

**systemat**

Impressively stylish



**systemat**

Impressively stylish

---

# Editorial

A sense of style in the kitchen

The systemat product line combines functionality with aesthetics. Clean lines, timeless designs and fine materials characterise the modern kitchen inside and out. Sustainability plays a key role, natural colours and energy-optimised electrical appliances are must-haves. A host of new features await you: from lighting integrated in the pull-out unit and 61 cm standard depth to the slimmest metal frame in the SLD pull-out system. Transform your kitchen into the centre of your home!

Produktserien systemat kombinerar funktionalitet med estetik. Rena linjer, tidlös design och fina material kännetecknar det moderna köket både på insidan och utsidan. Hållbarhet spelar en central roll, naturliga färger och energioptimerade elektriska apparater är ett måste. En mängd nya funktioner väntar på dig: från integrerad utdragsbelysning och 61 cm standarddjup till den tunnaste metallramen i SLD-utdragssystemet. Förvandla ditt kök till hemmets mittpunkt!

La linea systemat unisce funzionalità ed estetica. Linee pulite, design senza tempo e materiali pregiati caratterizzano la cucina moderna sia all'interno che all'esterno. La sostenibilità ha un ruolo fondamentale, i colori naturali e gli elettrodomestici a risparmio energetico sono un must. Ti aspettano tante novità: il sistema di illuminazione dei cassetti integrati, la profondità standard di 61 cm e la sottilissima ferramenta dei cassetti del sistema SLD. Trasforma la cucina nel cuore della tua casa!

Produktserien Systemat kombinerer funktionalitet med æstetik. Rene linjer, tidløst design og lækre materialer kendetegner det moderne køkken - både ude og inde. Bæredygtighed spiller en central rolle, mens naturlige farver og energioptimerede hvidevarer er musthaves. Glæd dig til alle de nye funktioner: Fra integreret udtræksbelysning og 61 cm standarddybde, til den tyndeste metalramme i SLD-udtrækssystemet. Gør dit køkken til hjemmets midtpunkt!

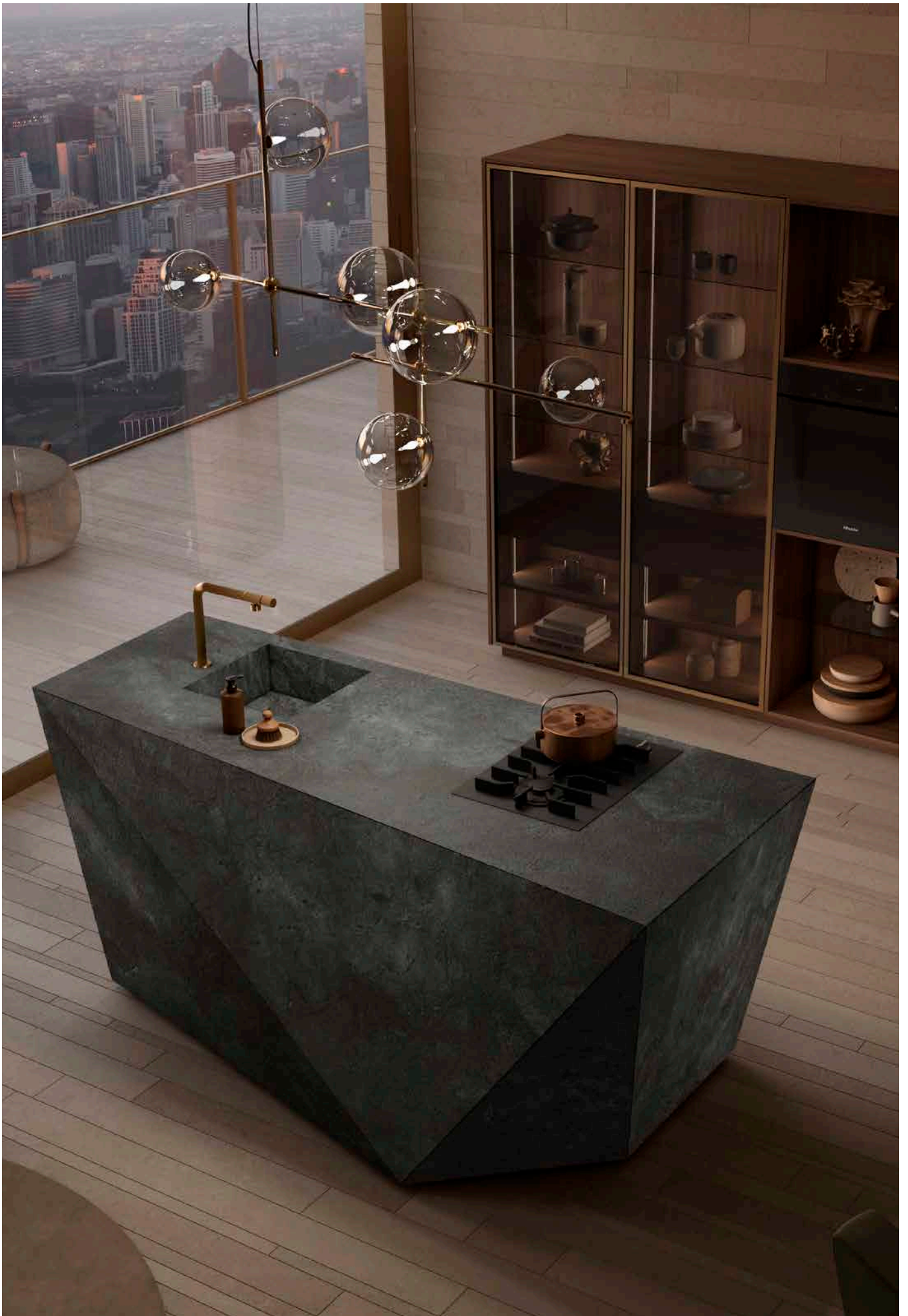

# Timeless values reinterpreted

Modern designs with traditional elements

Many people appreciate the balance between modernity and tradition. Conscious sustainability, the best craftsmanship and a return to family and social traditions are part of life. Do you prefer a harmonious blend of classic elements and modern accents that symbolise both consistency and progress? We would be delighted to take you on a journey and show you how we interpret the kitchen as an authentic living experience.

Många människor uppskattar balansen mellan modernitet och tradition. Medveten hållbarhet, det bästa hantverket och en återgång till familjetraditioner och sociala traditioner är en del av livet. Föredrar du en harmonisk blandning av klassiska element och moderna accenter som symboliserar både beständighet och framsteg? Vi tar gärna med dig på en resa och visar dig hur vi tolkar köket som en autentisk boendemiljö.

Sono in tanti quelli che apprezzano sempre di più l'equilibrio tra modernità e tradizione. Sostenibilità consapevole, lavorazione di alta qualità e ritorno alle tradizioni familiari e sociali fanno parte della vita. Preferisci unire l'armonia degli elementi classici con note di modernità che simboleggiano costanza e progresso? Saremo lieti di accompagnarti in questo viaggio per mostrarti la nostra visione dell'ambiente cucina come un'autentica esperienza di vita.

Mange mennesker værdsætter balancen mellem modernitet og tradition. Bevidst bæredygtighed, det bedste håndværk samt en tilbagevenden til familiære og sociale traditioner er en del af livet. Foretrækker du en harmonisk blanding af klassiske elementer og et moderne præg, der både symboliserer kontinuitet og fremskridt? Kom med på rejsen og lad os vise dig, hvordan vi fortolker køkkenet, som en autentisk boligoplevelse.



Viennese mesh: Proven style, fresh look







# Rethought, redone

Elegant oak and black oak

A special kitchen that combines traditional craftsmanship with modern design in a fascinating manner. The Viennese weave lends the fronts a nostalgic touch, while the clear lines and matt illuminated mouldings stand for contemporary elegance. Reminiscent of times gone by: The integrated hatch provides an unobstructed view of nature. A masterpiece of stylish kitchen architecture. Another special feature here: the 61 cm deep carcass offers plenty of space in the pull-out unit.

Ett speciellt kök som kombinerar traditionellt hantverk med modern design på ett fascinerande sätt. Wienerflätverket ger fronterna en nostalgisk touch, medan de klara linjerna och de matt belysta listerna står för modern elegans. En påminnelse om svunna tider: Den integrerade luckan ger en obehindrad utsikt över naturen. Ett mästerverk av elegant köksarkitektur. En annan speciell egenskap här: Den 61 cm djupa stommen ger gott om plats i utdragsskåpet.

Una cucina speciale che combina in modo affascinante l'artigianato tradizionale con il design moderno. La paglia di Vienna conferisce alle ante un tocco nostalgico, mentre le linee chiare e i profili gola opachi e illuminati suggeriscono eleganza contemporanea. Uno sguardo al passato: il passavivande integrato offre una scorcia sulla natura circostante. Un vero capolavoro di stile. Un'altra particolarità: la scocca profonda 61 cm offre molto spazio sistemare per gli oggetti nel cestone.

Et særligt køkken, der kombinerer traditionelt håndværk med moderne design - på fascinerende vis. Wienerflet giver fronterne et nostalgisk præg, mens de klare linjer og matbelyste lister emmer af moderne elegance. Minder om svundne tider: Den integrerede åbning giver fri udsigt til naturen. Et mesterværk af stilfuld køkkenarkitektur. Her finder du også noget særligt: Det 61 cm dybe stel giver god plads i udtrækket.

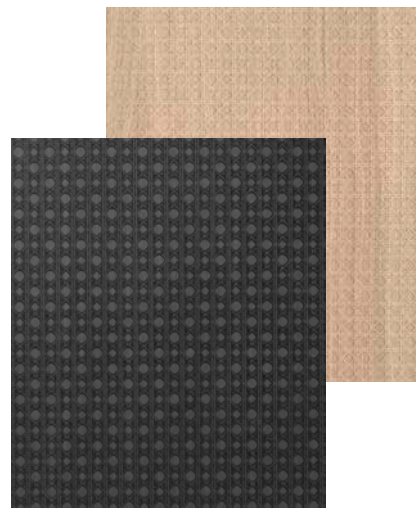

## AV 6085-GL

Elegant oak | Black oak

Elegant ek | Ek svart

Rovere elegante | Rovere nero

Eg-elegant | Eg-sort







---

# Functionality and elegance

Tandem swivel pull-out and design carcass in titanium

The tandem swivel pull-out in the high cupboard combines optimum handling with perfect aesthetics. With an elegant surface and seamless mechanism, it not only offers maximum storage space, but also an exclusive experience. The high-quality coating gives the pull-out unit a timeless elegance, while the designer carcass in titanium is a stylish addition to any modern kitchen.

Det svängbara tandemutdraget i skafferiet kombinerar optimal hantering med perfekt estetik. Med den eleganta ytan och sömlösa mekanismen erbjuds inte bara maximalt förvaringsutrymme utan också en exklusiv upplevelse. Den högkvalitativa beläggningen ger utdragsenheten en tidlös elegans, medan designstommen i titan är ett elegant tillskott till alla moderna kök.

Il sistema Tandem con scaffale estraibile nella colonna combina un'ottima maneggevolezza con un'estetica perfetta. Con una superficie elegante e un meccanismo continuo, non solo offre tanto spazio per riporre gli oggetti, ma anche un'esperienza esclusiva. Il rivestimento di qualità delle superfici conferisce allo scaffale un'eleganza senza tempo, mentre la scocca da design color titanio aggiunge un tocco di stile a qualsiasi cucina moderna.

Højskabets tandemudtræk kombinerer praktisk brug og æstetik perfekt. Den elegante overflade og letløbende mekanik leverer både maksimal opbevaringsplads samt en eksklusiv oplevelse. Kvalitetsbelægningen giver udtrækket en tidløs elegance, mens designerstellet i Titan sætter et smukt præg på ethvert moderne køkken.

# Display cabinet with a view

Slim metal frame in graphite and Parsol glass

The elegant display cabinet with Parsol glass and slim metal frame in graphite sets stylish accents in any room. The tinted glass and modest lighting make collector's items and decorative objects appear as if they have been soft-focused. The delicate frames create a modern, minimalist aesthetic. A centerpiece for exclusive living.

Det eleganta vitrinskåpet med Parsol-glas och smal metallram i grafit sätter stilfulla accenter i alla rum. Det tonade glaset och den dämpade belysningen gör att samlarobjekt och prydnadsföremål ser ut som om de har mjukfokuserats. De filigrana ramarna skapar en modern, minimalistisk estetik. En mittpunkt för exklusivt boende.

L'elegante vetrina con vetro Parsol e sottile telaio in metallo color grafite aggiunge un tocco di eleganza in ogni ambiente. I vetri colorati e l'illuminazione discreta fanno apparire i pezzi da collezione e gli oggetti decorativi come se fossero avvolti da un suggestivo effetto soft-focus. Le cornici sottili delle ante danno un'immagine moderna e minimalista. Un fiore all'occhiello per un ambiente esclusivo.

Den elegante vitrine, med Parsolglas og slank metalramme i grafit, sætter et stilfuldt præg på ethvert rum. Det tonede glas og den diskrete belysning får både samlarobjekter og pyntegenstande til at fremstå med blødere udtryk. De super slanke rammer skaber en moderne, minimalistisk æstetik. Et betagende blikfang i en eksklusivt indretning.











---

# For a sustainable, healthy home

Tried-and-test material with a modern twist

Linoleum, well-known and tried-and-tested as a floor covering, now also impresses as a sustainable material for kitchen fronts. Linoleum is made from natural raw materials such as linseed oil and wood flour. It offers a durable and easy-care surface, is environmentally friendly and versatile. Linoleum gives kitchen fronts a contemporary design combined with ecological responsibility. Ideal for modern and natural living concepts.

Linoleum, som är välkänt och beprövat som golvbeläggning, imponerar nu också som ett hållbart material för köksfronter. Linoleum tillverkas av naturliga råvaror som linolja och trämjöl. Det ger en slitstark och lättskött yta, är miljövänligt och mångsidigt användbart. Linoleum ger köksfronter en modern design i kombination med ekologiskt ansvar. Perfekt för moderna och naturliga boendekoncept.

Il linoleum, rinomato e comprovato rivestimento per pavimenti, ora convince anche come materiale sostenibile per i frontali delle cucine. Il linoleum è prodotto con materie prime naturali come l'olio di lino e la farina di legno. Materiale ecologico e versatile, offre una superficie durevole e di facile manutenzione. Il linoleum valorizza i frontali della cucina con un design contemporaneo unito alla responsabilità ecologica. Ideale per interni moderni e naturali.

Linoleum, der både er velkendt og gennemprøvet som gulvbelægning, imponerer også som bæredygtigt materiale til køkkenfronter. Linoleum fremstilles af naturlige råmaterialer, som linolie og træmel. Det giver en holdbar overflade, som er let at holde, miljøvenlig og alsidig. Linoleum giver køkkenfronterne et moderne design, kombineret med økologisk ansvarlighed. Perfekt til moderne og naturlige indretningskoncepter.

Linoleum: Soft feel, unique look





---

# Linoleum with a difference

Charming in smoky blue and black

A modern kitchen with linoleum fronts combines innovative design with sustainable elegance. The natural materials give it an inviting atmosphere. The surface feels pleasantly soft and warm, while the matt look gives this kitchen a perfect radiance. Linoleum in stylish colour combinations sets an example for sustainable elegance and contemporary living aesthetics.

Ett modernt kök med fronter i linoleum kombinerar innovativ design med hållbar elegans. De naturliga materialen skapar en inbjudande atmosfär. Ytan känns behagligt mjuk och varm, medan det matta utseendet ger köket en perfekt utstrålning. Linoleum i snygga färgkombinationer är ett föredöme för hållbar elegans och modern boendeestetik.

Una cucina moderna con ante in linoleum coniuga un design innovativo con un'eleganza sostenibile. I materiali naturali creano un'atmosfera accogliente. La superficie è piacevolmente morbida e calda, mentre l'aspetto opaco conferisce a questa cucina una perfetta luminosità. Il linoleum, disponibile in eleganti combinazioni di colori, è un esempio di eleganza sostenibile e di estetica abitativa contemporanea.

Et moderne køkken med linoleumsfronter kombinerer innovativt design med bæredygtig elegance. De naturlige materialer skaber en indbydende atmosfære. Overfladen føles behageligt blød og varm, mens det matte look giver køkkenet en perfekt udstråling. Linoleum i stilfulde farvekombinationer er et eksempel på bæredygtig elegance og moderne boligæstetik.



## AV 7080

Smoky blue  
Rökblå  
Blu fumo  
Røgblå

## AV 7080

Black  
Svart  
Nero  
Sort









---

# Smart door solution: Pocket Doors

Space-saving and special

Pocket Doors are an elegant and space-saving solution in open-plan and modern living concepts. They act as elegant room dividers and skilfully conceal work surfaces and storage space. The sliding doors disappear invisibly into a wall pocket, creating more space and flexibility. Pocket Doors combine functionality with stylish design and the harmoniously matching carcass in natural fine oak lends a clean and elegant aesthetic to any home.

Pocket Doors är en elegant och platsbesparande lösning för öppna planlösningar och moderna boendekoncept. De fungerar som eleganta rumsavdelare och döljer arbetsytor och förvaringsutrymmen på ett smart sätt. Pocket Doors försvinner osynligt in i en väggspringa, vilket skapar mer utrymme och flexibilitet. Pocket Doors kombinerar funktionalitet med elegant design och den harmoniskt matchande stommen i naturlig, fin ek ger en ren och elegant estetik till alla hem.

Le ante a scomparsa sono una soluzione elegante e salvaspazio negli open space e negli ambienti moderni. Fungono da eleganti divisori di ambienti e nascondono abilmente piani di lavoro e mensole a giorno. Le porte scorrevoli scompaiono in modo invisibile in un vano laterale, creando più spazio e flessibilità. Le Pocket Door combinano la funzionalità con un design elegante e la scocca coordinata in rovere fine naturale conferisce un'estetica pulita ed elegante a qualsiasi casa.

Pocket Doors er en elegant og pladsbesparende løsning i åbne og moderne boligkoncepter. De fungerer som elegante rumdelere og skjuler diskret arbejdsflader og opbevaring. Skydedørene forsvinder usynligt ind i en væglomme, som skaber bedre plads og større fleksibilitet. Pocket Doors kombinerer funktionalitet med stilfuldt design, mens de harmonisk matchende stel, i fin eg-natur, spreder ren og elegant æstetik i ethvert hjem.



# Visibly beautiful: The integrated lighting for pull-out units

A natural ray of hope for cutlery and co.

The high-quality SLD pull-out unit with a frame measuring just eight millimetres is a real design element in the kitchen and usually receives too little attention. This is why it is combined here with integrated lighting and the new OrganiQ interior organisation system. The integrated interior lighting of the pull-out unit ensures optimum visibility even in the rearmost compartments. A clever aid for finding specific items or selecting the right cutlery. The real wood interior organisation gives the kitchen even more exclusivity and ensures tidy and stylish storage.

Det högkvalitativa SLD-utdragssystemet med en ram som bara mäter åtta millimeter är ett riktigt designelement i köket och får vanligtvis för lite uppmärksamhet. Därför kombineras det här med integrerad belysning och det nya inredningssystemet OrganiQ. Den integrerade interiörbelysningen i utdragsskåpet ger optimal sikt även in i de bakre facken. Ett smart hjälpmedel för att hitta specifika artiklar eller välja rätt bestick. Inredningen i äkta trä gör köket ännu mer exklusivt och ger en snygg och stilren förvaring.

L'esclusiva ferramenta per cassette SLD, con sponde di spessore di soli otto millimetri, è un vero e proprio elemento di design in cucina, che solitamente desta poca attenzione. Per questo motivo è stato abbinato al sistema di illuminazione integrata e al nuovo organizer interno OrganiQ. L'illuminazione interna integrata del cassetto garantisce una visibilità ottimale anche nei vani più nascosti. Una soluzione intelligente per trovare oggetti specifici o per scegliere le posate giuste. L'organizer interno in vero legno conferisce alla cucina la massima esclusività e permette di sistemare gli oggetti in modo ordinato ed elegante.

Rammen på det lækre SLD-udtræk måler blot otte millimeter og er et ægte designelement i køkkenet, der typisk får for lidt opmærksomhed. Derfor kombineret denne integreret belysning med det nye indretningssystem OrganiQ. Udtrækkets integrerede, indvendige belysning sikrer optimalt overblik, også over de bageste rum. En smart hjælp, når du skal finde noget særligt eller vælge det rette bestik. Den indvendige organisering, udført i ægte træ, styrker køkkenets eksklusivitet og sikrer overskuelig og flot opbevaring.





# Craftsmanship in perfection

Box joint solid wood pull-out units

The box joint, solid wood pull-out units combine classic craftsmanship with modern functionality. Precisely machined notches ensure durability and stability. They also look extremely decorative. Fine solid wood gives the cupboard interior an elegant look, while the careful workmanship guarantees the highest quality. An excellent choice for anyone who values stylish and sustainable interior design.

De galvaniserade utdragslådorna i massivt trä kombinerar klassiskt hantverk med modern funktionalitet. Precisionsbearbetade skårer ger hållbarhet och stabilitet. De ser också mycket dekorativa ut. Fint massivt trä ger skåpsinredningen ett elegant utseende, medan det noggranna utförandet garanterar högsta kvalitet. Ett utmärkt val för alla som värdesätter snygg och hållbar inredning.

I cestoni in legno massello con giunzione a coda di rondine combinano la classica artigianalità con la funzionalità moderna. La lavorazione accurata degli intagli assicura durata e stabilità. Inoltre, hanno un aspetto estremamente decorativo. Il pregiato legno massello conferisce all'interno dell'armadio un aspetto elegante, mentre l'accurata lavorazione garantisce la massima qualità. Una scelta eccellente per chi apprezza un design d'interni raffinato e sostenibile.

De galvaniserede udtræk i massivt træ kombinerer klassisk håndværk med moderne funktionalitet. Præcist bearbejdede indhak sikrer stor holdbarhed og stabilitet. Det ser også super dekorativt ud. Ædelt, massivt træ giver skabets interiør et elegant look, mens den omhyggelige forarbejdning garanterer topkvalitet. Et fremragende valg for alle, der sætter pris på stilfuldt og bæredygtigt interiørdesign.



---

# Styles, colours and materials that surprise

Creative designs for your personal style of living

The interiors of individualists reflect their unique personality and creative expression. Those who prefer unconventional designs and customised pieces of furniture emphasise their independence and originality. It is the mixture of different styles, colours and materials that create a harmonious but unique overall picture. We would be happy to show you what we mean by customised kitchen design.

Individualisternas interiörer speglar deras unika personlighet och kreativa uttryck. De som föredrar okonventionell design och skräddarsydda möbler markerar sitt oberoende och sin originalitet. Det är blandningen av olika stilar, färger och material som skapar en harmonisk men unik helhetsbild. Vi visar dig gärna vad vi menar med skräddarsydd köksdesign.

Gli interni degli individualisti riflettono la loro personalità unica e la loro espressione creativa. Chi preferisce design non convenzionali e mobili personalizzati sottolinea la sua indipendenza e originalità. Il mix di stili, colori e materiali diversi crea un quadro d'insieme armonioso ma unico. Saremo lieti di mostrarti cosa intendiamo per progettazione di cucine su misura.

Individualisters indretning afspejler deres unikke personlighed og kreative udtryk. Enhver, der foretrækker utraditionelt design og skæddersyede møbler, understreger deres uafhængighed og originalitet. Det er blandingen af forskellige stile, farver og materialer, der skaber et harmonisk, men unikt helhedsbillede. Vi vil gerne vise dig, hvad vi mener med skæddersyet køkkendesign.









# Summer feeling all year round

Expressive colour lends Mediterranean flair

Ambience like in the south: the matt lacquered tall cupboard run in terracotta dominates the room and skilfully sets the scene. The wall colour in the same shade emphasises the sunny look. The crystal white kitchen island, made from durable laminate, in a minimalist design creates a fresh accent. An inviting kitchen that is both aesthetically pleasing and practical – ideal for style-conscious individualists.

Atmosfär som i södern: Den mattlackade raden av högskåp i terracotta dominerar rummet och ramar in scenen på ett skickligt sätt. Väggfärgen i samma nyans understryker den soliga looken. Den kristallvita köksön av slitstarkt laminat i minimalistisk stil. Designen skapar en fräsch accent. Ett inbjudande kök som är både estetiskt tilltalande och praktiskt - perfekt för stilmedvetna individualister.

Atmosfera mediterranea: la colonna laccata opaca color terracotta domina l'ambiente e si mette magistralmente al centro della scena. Il colore delle pareti nella stessa tonalità enfatizza la sua solarità. L'isola in bianco cristallo in robusto laminato dal design minimalista aggiunge un tocco di freschezza. Una cucina invitante, esteticamente gradevole e pratica, ideale per gli individualisti attenti allo stile.

Sydlig stemning: Det matlakerede højskab i terracotta dominerer rummet og sætter selvbevidst scenen. Vægfarven i samme nuance understreger den solrige udstråling. Den krystalhvide køkkenø af slidstærkt laminat i et minimalistisk design skaber en frisk effekt. Et indbydende køkken, der både er æstetisk og praktisk - ideelt til stilbevidste individualister.

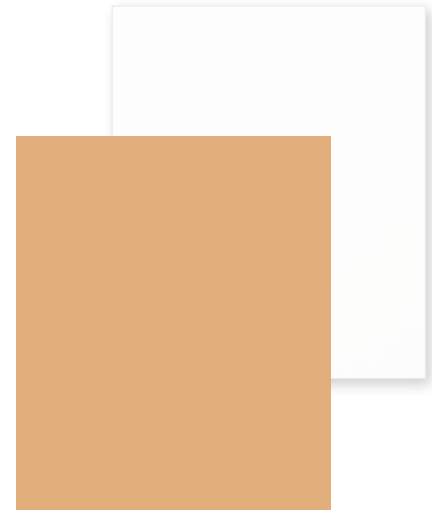

## AV 6000

NCS S 4040-Y50R

## AV 1000

Crystal white  
Kristallvit  
Bianco cristallo  
Krystalhvid

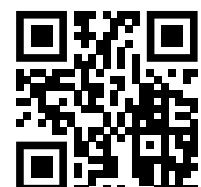



---

# A strong structure as a basis

Concrete and cement: Versatility moulded into shape

Concrete and cement can be integrated into decorative kitchen designs in a variety of ways. They give worktops, furniture fronts, floors and walls a modern, industrial character. Thanks to their robustness and durability, these materials are ideal for surfaces subject to heavy use. Different textures and colours can be used to create unique, customised designs that combine functionality and style.

Betong och cement kan integreras i dekorativa köksdesigner på en mängd olika sätt. De ger bänkskivor, möbelfronter, golv och väggar en modern, industriell karaktär. Tack vare robusthet och hållbarhet är dessa material idealiska för ytor som utsätts för hårt slitage. Olika texturer och färger kan användas för att skapa unik, skräddarsydd design som kombinerar funktionalitet och stil.

Calcestruzzo e cemento possono essere inseriti nei progetti di cucine come nota decorativa in vari modi, conferendo a top, ante, pavimenti e pareti un carattere moderno e industriale. Grazie alla loro robustezza e durata, questi materiali sono ideali per le superfici soggette ad un uso intenso. È possibile utilizzare texture e colori diversi per creare design unici e personalizzati che uniscono funzionalità e stile.

Beton og cement integreres varieret i smukke køkken-designs. Det giver bordplader, møbelfronter, gulve og vægge en moderne, industriel karakter. Materialernes robusthed og holdbarhed gør dem perfekte til overflader, der skal modstå en krævende behandling. De forskellige farver og teksturer bruges til at skabe unikke, skræddersyede designs, der kombinerer funktionalitet og stil.











# Concrete shows its cosy side

Perfect interplay:  
High-quality architecture with decorative concrete

This kitchen in concrete grey is a prime example of the use of unusual materials. It impresses with its typical concrete colour and the visible and perceptible blowholes in the concrete look of the fronts. The easy-care laminate worktop complements the modern design and the 61 cm deep pull-out units provide plenty of space in the island. A modern concrete look combined with illuminated glass shelves – timeless and stylish aesthetics that are both functional and attractive.

Det här köket i betonggrått är ett utmärkt exempel på användning av ovanliga material. Det imponerar med typisk betongfärg och de synliga och förnimbara blåshålen i fronternas betong. Den lättskötta bänkskivan i laminat och fronterna kompletterar den moderna designen och de 61 cm djupa utdragen säkerställer gott om plats på ön. En modern betonglook i kombination med upplysta glashyllor - tidlös och stilren estetik som är både funktionell och attraktiv.

Questa cucina in calcestruzzo grigio è un ottimo esempio dell'impiego di un materiale insolito. Colpisce per il tipico colore del cemento e per i fori visibili e percepibili sulla superficie delle ante. Il top in laminato di facile cura e le ante completano il design moderno e i cassetti profondi 61 cm offrono molto spazio nell'isola. Una moderna finitura effetto cemento combinato con ripiani in vetro illuminati: un'estetica senza tempo ed elegante, funzionale e attraente.

Dette køkken i betongrå er et godt eksempel på brugen af usædvanlige materialer. Det imponerer med typiske betonfarver samt synlige og mærkbare huller i fronternes betonlook. Den vedligeholdelsesvenlige laminatbordplade og fronter supplerer det moderne design, og de 61 cm dybe udtræk sikrer masser af plads i øen. Moderne betonlook kombineret med oplyste glashylder - tidløs og stilfuld æstetik, der både er funktionel og flot.



## AV 7010-GL

Grey concrete  
Betong-grå  
Calcestruzzo grigio  
Beton-grå

## AV 1000-GL

Greige  
Greige  
Grigio-beige  
Grå



---

# The best of two colour worlds

Warm peach tone and cool grey concrete

This sideboard with its special colour shade benefits from the blush effect: Targeted colour accents liven up any room. Special peach tones create a warm atmosphere and provide a deliberate contrast to the kitchen fronts in a cool concrete look. The modern sideboard offers plenty of storage space and creates a charming ambience. It is extremely functional – and absolutely visually appealing.

Detta sideboard med sin speciella färgnyans drar nytta av blush-effekten: riktade färgaccenter livar upp vilket rum som helst. Speciella persikotoner skapar en varm atmosfär och ger en medveten kontrast till köksfronterna i sval betonglook. Det moderna sideboardet erbjuder gott om förvaringsutrymme och skapar en charmig atmosfär. Det är extremt funktionellt - och visuellt definitivt tilltalande.

Questa credenza con la sua particolare tonalità aggiunge una nota rosseggiante: tocchi di colore mirati ravvivano qualsiasi ambiente. Le particolari tonalità color pesca creano un'atmosfera calda e un voluto contrasto con le ante in freddo calcestruzzo. La moderna credenza è molto capiente e crea un ambiente affascinante. È estremamente funzionale e assolutamente accattivante.

Skænkens særlige tone nyder godt af rouge-effekten: de målrettede nuancer spreder liv i ethvert rum. Specielle ferskenfarver skaber en varm atmosfære og danner en bevidst kontrast til køkkenfronter i cool betonlook. Den moderne skænk har masser af opbevaringsplads og sørger for charmerende stemning. Den er ekstremt funktionel - og visuelt utroligt attraktiv.



**AV 6000**  
NCS S5030-Y70R

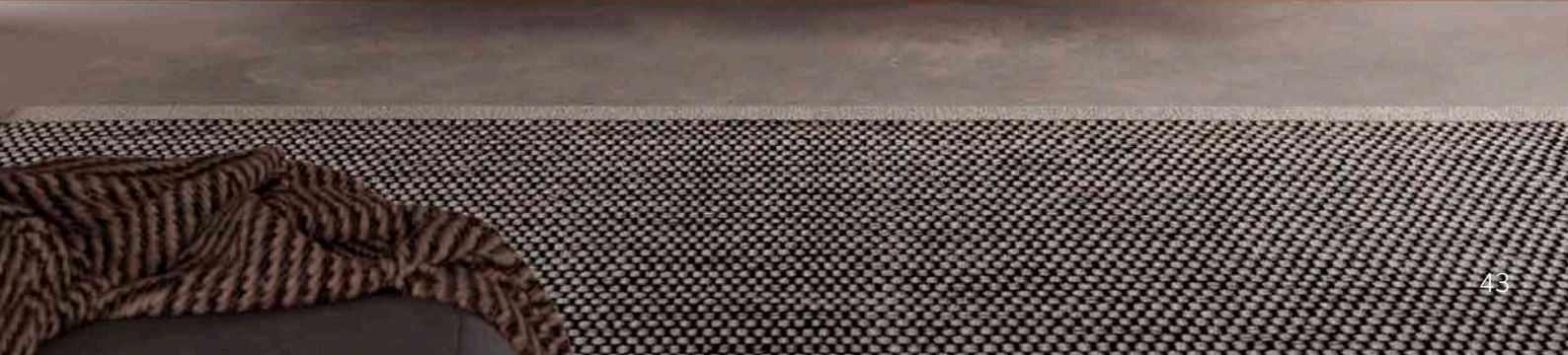







# Cement meets design

Kitchen with a new look and feel

Grey cement look as a statement for urban flair. The fronts in a dark and light cement look have a characteristically rough texture. Small pores and unevenness can be felt on the textured surface. Open shelves with illuminated glass shelves and narrow metal frames provide additional storage space. A balanced interplay of design and functionality for individual urban living.

Grå cementlook som ett statement för urban känsla. Fronterna i mörk och ljus cementlook har en karaktäristisk grov struktur. Små porer och ojämnheter kan kännas på den strukturerade ytan. Öppna hyllor med belysta glashyllor och smala metallramar ger extra förvaringsutrymme. Ett balanserat samspel mellan design och funktionalitet för ett individuellt boende i staden.

La finitura effetto cemento grigio è un'ode allo stile urbano. Le ante in cemento scuro e chiaro si distinguono per la loro caratteristica struttura ruvida. Sulla superficie strutturata si possono percepire piccoli pori e irregolarità. Gli scaffali aperti con ripiani in vetro illuminati e sottile telaio in metallo offrono ulteriore spazio di appoggio. Un'equilibrata sinergia di design e funzionalità per una casa in città su misura.

Gråt cementlook som statement for urban flair. Fronterne i mørkt og lyst cementlook har en karakteristisk, ru struktur. Du mærker de små porer og ujævnheder på den teksturerede overflade. Åbne reoler med oplyste glashylder og slanke metalrammer sikrer ekstra opbevaringsplads. Et afbalanceret samspil mellem design og funktionalitet til individuel, urban indretning.



## AV 2010-GL

Light cement effect  
Cement-ljus effekt  
Effetto cemento chiaro  
Cement-lys effekt

## AV 2010-GL

Grey cement effect  
Cement-grå effekt  
Effetto cemento scuro  
Cement-grå effekt



---

# Nature as a perfect role model

Visually strong, haptically impressive: Laminates in granite look

Surfaces with granite decor capture the authentic structure and elegant appearance of real granite. At the same time, they offer the practical advantages of laminate surfaces. These high-quality replicas can be used to realise sophisticated design ideas that are almost indistinguishable from real granite in terms of their look and feel. Granite decors are available in different colours – they can be used to create unique designs.

Ytor med granitdekor fångar den autentiska strukturen och det eleganta utseendet hos äkta granit. Samtidigt har de laminatytornas praktiska fördelar. Dessa högkvalitativa efterbildningar kan användas för att förverkliga sofistikerade designidéer och är nästan omöjliga att skilja från äkta granit när det gäller utseende och känsla. Granitdekorer finns i olika färger - de kan användas för att skapa unika mönster.

Le superfici con finitura in effetto granito riproducono la struttura autentica e l'aspetto elegante del vero granito, offrendo allo stesso tempo i vantaggi pratici delle superfici in laminato. Queste repliche di alta qualità possono essere utilizzate per realizzare progetti sofisticati, pressoché indistinguibili dal granito autentico sia per aspetto che al tatto. Le finiture effetto granito sono disponibili in diversi colori e possono essere utilizzate per creare design unici.

Overflader med granitlook fanger den ægte granits autentiske struktur og elegante udseendet. Samtidig rummer de alle laminatoverfladens praktiske fordele. Replikaen i topkvalitet bruges til at realisere avancerede designideer, som næsten ikke skelnes fra ægte granit, når det gælder udseende og følelse. Granitlook fås i forskellige farver - som bruges til at skabe unikke designs med.





Granite decor: Structure with timeless elegance





# A delicate kick of freshness

Granite-beige look impresses all along the line

A dream kitchen in delicate granite beige. It radiates harmonious elegance that fills the room with warmth. The fine, soft nuances of the beige granite look blend beautifully into the light-flooded ambience. A timeless visual beauty, while the sophisticated design seamlessly combines functionality and style. This is where modern design meets classic grace. Every moment in this kitchen is a pleasure for the senses.

Ett drömkök i delikat granitbeige. Det utstrålar harmonisk elegans som fyller rummet med värme. De fina, mjuka nyanserna i den beige granitlooken smälter vackert in i den ljusa atmosfären. En tidlös visuell skönhet, medan den sofistikerade designen sömlöst kombinerar funktionalitet och stil. Här möts modern design och klassisk elegans. Varje ögonblick i det här köket är en njutning för sinnen.

Una cucina da sogno in un delicato beige granito, che diffonde un'eleganza armoniosa e riempie l'ambiente di calore. Le sottili e morbide sfumature beige del granito si fondono magnificamente con l'ambiente luminoso. Una bellezza senza tempo, mentre il design sofisticato combina perfettamente funzionalità e stile. Qui il design moderno incontra l'eleganza classica. Ogni momento in questa cucina è un piacere per i sensi.

Et drømmekøkken i sart granit-beige. Det udstråler harmonisk elegance, som fylder rummet med varme. De fine, bløde nuancer i beige granitlook smelter smukt ind i atmosfæren, som spreder lys overalt. Optisk en tidløs skønhed, mens det gennemtænkte design effektivt kombinerer funktionalitet og stil. Her møder moderne design klassisk elegance. Hver detalje i dette køkken er en nydelse for sanserne.



## AV 3050

Beige granite effect  
Granit-beige effekt  
Effetto granito beige  
Granit-beige effekt

## AV 6000

Natural umber  
Umbra naturlig  
Terra d'ombra naturale  
Umbra-natur













# Like a rock in the surf

Aesthetic with structure

The harmonious overall appearance of this kitchen is characterised by modern elegance and natural strength. The deep, textured nuances of the decor in granite dark grey create a powerful presence and lend the room an enduring, timeless atmosphere. Every glance is reminiscent of the breathtaking beauty of real natural stone. The sophisticated design combines functionality with aesthetic pleasure.

Det harmoniska helhetsintrycket av detta kök kännetecknas av modern elegans och naturlig kraft. De djupa, strukturerade nyanserna i inredningen i mörkgrå granit skapar en kraftfull närvaro och ger rummet en bestående, tidlös atmosfär. Vid varje titt påminns man om den hisnande skönheten hos äkta natursten. Den sofistikerade designen kombinerar funktionalitet med estetisk njutning.

La sensazione di armonia in questa cucina è caratterizzata da un'eleganza moderna e da una forza naturale. Le sfumature profonde e strutturate della finitura effetto granito grigio scuro creano una presenza potente e conferiscono all'ambiente un'atmosfera di stabilità senza tempo. Ogni sguardo ricorda la bellezza mozzafiato della vera pietra naturale. Il design sofisticato combina funzionalità ed estetica.

Køkkenet harmoniske helhedsindtryk udstråler moderne elegance og naturlig styrke. Designets dybe, strukturerede nuancer i granit-mørkegrå skaber en stærk tilstedeværelse og giver rummet en varig, tidløs atmosfære. Hvert eneste blik minder dig om de ægte klippers betagende skønhed. Den gennemtænkte formgivning kombinerer funktionalitet med æstetisk nydelse.



## AV 3050

Dark grey granite effect  
Granit-mörkgrå effekt  
Effetto granito grigio scuro  
Granit-mørkegrå effekt

## AV 6000

Greige  
Greige  
Grigio-beige  
Grå



Metallic shimmer for an exclusive look







# Metallic surfaces with depth effect

Gentle radiance for customised kitchen design

Surfaces made of modern polymer glass with a metallic shimmer are absolutely on trend. They emphasise modern design and have a depth effect. The shimmer effect creates a sophisticated and highquality look. The light is reflected and makes rooms appear brighter and larger. The roller shutter cabinets with polymer glass and the sliding worktop are additional eye-catchers.

Ytor av modernt polymerglas med metalliskt skimmer är definitivt trendigt. De framhäver modern design och har en djupeffekt. Skimmereffekten skapar en sofistikerad och högkvalitativ look. Ljuset reflekteras och gör att rummen upplevs som ljusare och större. Rulljalousiskåpen med polymerglas och den skjutbara bänkskivan är ytterligare blickfång.

Le superfici in vetro polimerico moderno con riflessi metallici sono assolutamente di tendenza. Sottolineano il design moderno e aggiungono un effetto di profondità. L'effetto metallico crea un look sofisticato e raffinato. La luce viene riflessa e fa apparire gli ambienti più luminosi e più grandi. I mobili a serrandina in vetro polimerico e i top scorrevoli sono elementi che catturano tutti gli sguardi.

Overflader af moderne polymerglas med metallisk skær er super trendy. De fremhæver moderne design og giver god dybdevirkning. Glimmereffekten skaber et elegant og kvalitetslook. Lyset reflekteres og får rummene til at virke større og lysere. Jalousiskabene med polymerglas og den mobile bordplade skaber ekstra blikfang.

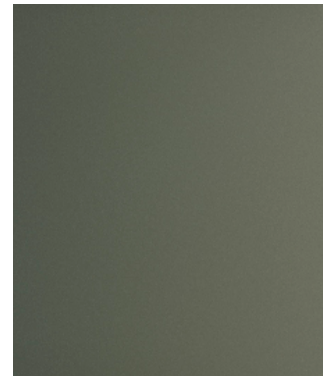

## AV 5015

Metallic olive green

Olivgrön metallic

Verde oliva metallizzato

Olivengrøn metallic







---

# Industrial style perfectly executed

Very typical in contemporary colours

This kitchen shows that cool architecture and cosy sand tones harmonise perfectly. The colours combine urban elegance with natural warmth. Matching details: The hob is located under the movable worktop. The industrial style is particularly suitable for large open-plan kitchens because it creates a clean and organised atmosphere.

Det här köket visar att sval arkitektur och trivsamma sandnyanser harmonierar perfekt. Färgerna kombinerar urban elegans med naturlig värme. Matchande detaljer: Hällen är placerad under den flyttbara bänkskivan. Den industriella stilen är särskilt lämplig för stora kök med öppen planlösning, eftersom den skapar en ren och organiserad atmosfär.

Questa composizione dimostra che la freddezza dell'architettura si combina alla perfezione con accoglienti tonalità sabbia. I colori coniugano l'eleganza urbana con il calore naturale. Accessori abbinabili: il piano di cottura sotto il piano di lavoro mobile. Lo stile industriale è particolarmente adatto alle grandi cucine open space, in quanto crea un'atmosfera pulita e organizzata.

Dette køkken viser, at kølig arkitektur og hyggelige sandfarver harmonerer perfekt. Farverne kombinerer urban elegance med naturlig varme. Matchende detaljer: Kogepladen sidder under den mobile bordplade. Den industrielle stil egner sig ekstra godt til store, åbne køkkener, hvor den skaber en enkel og organiseret stemning.

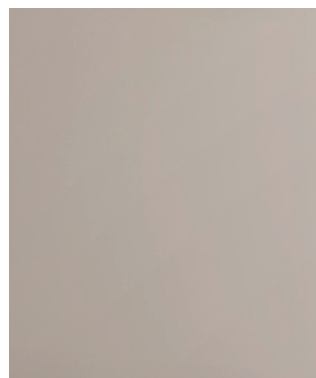

## AV 5015

Sand beige

Sandgrå

Beige sabbia

Sandgrå









---

# Naturally high quality: Sustainable living

Setting the course for a future worth living

Consciously living sustainably also includes living. The focus here is on renewable energies, ecological building materials, minimised energy consumption and the sharing of resources through community projects. The aim is to create spaces that combine both aspects: Environmental friendliness and a high quality of living. We present kitchen ideas for sustainable living that meet the highest quality standards.

Att medvetet leva hållbart inbegriper även boendet. Här ligger fokus på förnybar energi, ekologiska byggmaterial, minimerad energiförbrukning och delning av resurser genom samhällsprojekt. Målet är att skapa utrymmen som kombinerar båda aspekterna: miljövänlighet och hög livskvalitet. Vi presenterar köksidéer för en livsstil och ett hållbart boende som uppfyller de högsta kvalitetsstandarderna.

Vivere consapevolmente in modo sostenibile significa anche arredare la casa secondo gli stessi principi. L'attenzione è rivolta alle energie rinnovabili, ai materiali da costruzione ecologici, alla riduzione del consumo energetico e alla condivisione delle risorse attraverso progetti comunitari. L'obiettivo è creare spazi che uniscano entrambi gli aspetti: rispetto dell'ambiente e alta qualità abitativa. Ti presentiamo idee di cucine per una vita sostenibile che soddisfano i più alti standard di qualità.

At leve bevidst og bæredygtigt omfatter også hjemmets indretning. Her er der fokus på vedvarende energi, økologiske byggematerialer, minimalt energiforbrug og ressourcedeling via fællesskabsprojekter. Målet er at skabe rum, der kombinerer begge aspekter: miljøvenlighed og høj livskvalitet. Vi præsenterer køkkenideer til en bæredygtig livsstil, der opfylder de højeste kvalitetsstandarder.

---

# The vision: Design Milano

The cooking island is an innovative small living solution. It combines a compact construction with functionality and modern design. The Milano utilises space efficiently, integrates all the necessary kitchen functions and suits minimalist lifestyles. Perfect for small flats in the world's metropolises: Maximum comfort in minimum space.

Matlagningsön är en innovativ lösning för Small Living. Den kombinerar en kompakt konstruktion med funktionalitet och modern design. Milano använder utrymmet effektivt integrerar alla nödvändiga köksfunktioner och passar minimalistisk livsstil. Perfekt för små lägenheter i världens metropoler: maximal komfort på minimal yta.

L'isola è un'innovativa soluzione per i living di piccole dimensioni. Combina una struttura compatta con funzionalità e design moderno. Milano utilizza lo spazio in modo efficiente, integra tutte le funzioni indispensabili della cucina e si adatta a stili di vita minimalisti. Perfetto per i piccoli appartamenti delle metropoli: massimo comfort in uno spazio minimo.

Kogeøen er en innovativ Small-Livingløsning. Den kombinerer kompakt konstruktion med funktionalitet og moderne design. Milano udnytter pladsen effektivt, integrerer alle nødvendige køkkenfunktioner og matcher en minimalistisk livsstil. Perfekt til mindre lejligheder i verdens metropoler: maksimal komfort på minimal plads.

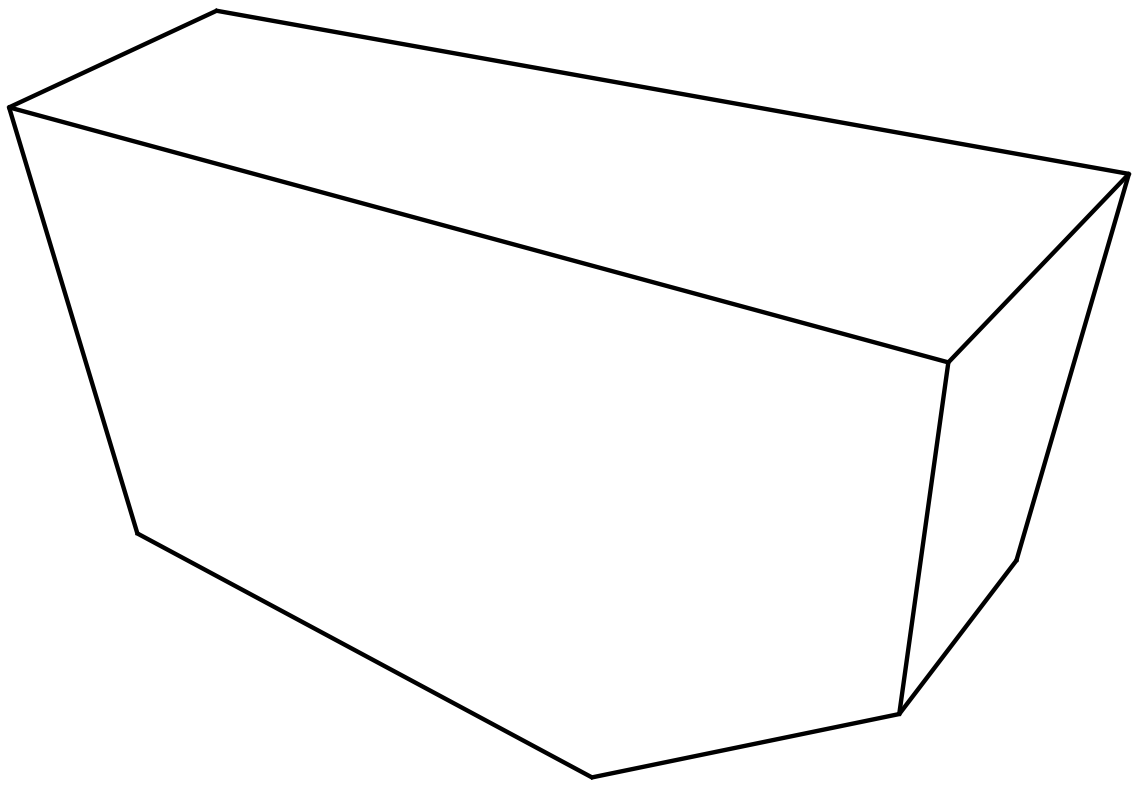









# Unique aesthetics: The new Stone Age

Polygonal cooking island sets standards

The single-stone-look cooking island: a masterpiece of minimalist design. The geometric lines and natural texture of the natural stone create a powerful presence. It is not only a workstation, but also an object of art – ideal for small living concepts that emphasise originality and elegance. The perfect complement: The high cupboard in dark wood decor with a fine grain and glass doors with a bronze-coloured metal frame.

Matlagningsön som en enda sten: ett mästerverk av minimalistisk design. De geometriska linjerna och naturstenens naturliga struktur skapar en kraftfull närvaro. Det är inte bara en arbetsstation, utan också ett konstföremål - perfekt för små boendekoncept där originalitet och elegans betonas. Det perfekta komplementet: högskåpet i mörk trädecor med fin ådring och glasdörrar med bronsfärgad metallram.

L'isola con effetto monolite: un capolavoro di design minimalista. Le linee geometriche e la superficie della pietra naturale creano una presenza autorevole nell'ambiente. Ideale per living piccoli, non si tratta solo di una postazione di lavoro, ma anche di un'opera d'arte che sottolinea la sua originalità ed eleganza. L'aggiunta perfetta: la colonna in legno scuro con venature fini, ante in vetro e telaio in metallo color bronzo.

Kogeøen med et-stens-look: et mesterværk i minimalistisk design. De geometriske linjer og naturstenens naturlige tekstur skaber en stærk udstråling. Det er ikke bare et arbejdsområde, men også et kunstobjekt - ideelt til Small-Living-koncepter, der lægger vægt på originalitet og elegance. Det perfekte supplement: Højskabet i mørkt træ med fine åretegninger og glasdøre med bronzefarvede metalrammer.



## AV 6088

Elegant walnut  
Nötträd elegant  
Noce elegante  
Valnød-elegant



---

# Strong stone for modern designs

An experience for all the senses

Stone and stone veneer are revolutionising modern kitchen design. The authentic texture and play of colours bring nature right into the home. Stone veneer, as a lighter alternative, enables flexible kitchen designs without compromises. The fronts and worktops are durable, easy to clean and give every kitchen a timeless, powerful character. Real stone in the kitchen is special – and impresses both visually and haptically.

Sten och stenfaner revolutionerar den moderna köksdesignen. Den autentiska strukturen och färgspelet för naturen rakt in i hemmet. Stenfaner, som är ett lättare alternativ, möjliggör flexibel köksdesign utan kompromisser. Fronterna och bänkskivorna är slitstarka, lätta att rengöra och ger varje kök en tidlös, kraftfull karaktär. Äkta sten i köket är speciellt - och imponerar både visuellt och haptiskt.

La pietra e il rivestimento in pietra stanno rivoluzionando il design delle cucine moderne. La texture autentica e il gioco di colori portano la natura tra le mura di casa. Il rivestimento in pietra, come alternativa più leggera, consente di progettare cucine flessibili senza compromessi. Le ante e i top sono resistenti, facili da pulire e conferiscono a ogni cucina un carattere energico e senza tempo. La pietra naturale vera in cucina è raffinata ed è di sicuro effetto sia alla vista che al tatto.

Sten og stenfinér revolutionerer moderne køkkendesign. Den autentiske tekstur og farvespillet bringer naturen direkte ind i hjemmet. Stenfinér er et lettere alternativ, som giver mulighed for fleksible køkken-designs - uden kompromiser. Fronterne og bordpladerne er holdbare, nemme at holde og giver ethvert køkken et tidløs, kraftfuld karakter. Ægte sten i køkkenet kan noget særligt - og imponerer både visuelt og mærkbart.







# A strong connection – stone and architecture

Symbiosis of form and function

Successful kitchen design realised in top form. The elegant Black Star stone veneer front is a feast for the eyes and the natural texture of the stone veneer is extremely exclusive. In combination with the blue fronts from the exclusive NCS colour system, they create a timeless, stylish ambience. Further highlights: The utility room accessible through the kitchen unit and the sliding worktop flying bridge. This is where innovative spatial planning meets aesthetic sophistication.

Lyckad köksdesign när den är som bäst. Den eleganta Black-star-fronten i stenfaner är en fröjd för ögat och stenfanerets naturliga struktur är ytterst exklusiv. I kombination med de blå fronterna från det exklusiva NCS-färgsystemet skapar de en tidlös och elegant atmosfär. Ytterligare höjdpunkter: förrådet som nås via köksenheten och den skjutbara bänkskivan flying bridge. Det är här som innovativ rumsplanering möter estetisk sofistikerad.

Un progetto riuscito e realizzato al meglio. L'elegante anta in pietra Black Star è una gioia per gli occhi e la texture naturale del rivestimento in pietra è esclusiva. In combinazione con le ante laccate blu denna scala NCS, creano un ambiente elegante e senza tempo. Altri punti di forza: il ripostiglio accessibile attraverso il passaggio tra le colonne e il piano di lavoro "flying bridge". È qui che la progettazione innovativa degli spazi incontra la raffinatezza estetica.

Vellykket køkkendesign forvandlet til perfekt form. Den elegante stenfinérfront Sort stjerne er en fryd for øjet, og stenfinérens naturlige tekstur er ekstremt eksklusiv. Kombineret med de blå fronter fra det eksklusive NCS-farvesystem skaber de en tidløs, stilfuld atmosfære. Ekstra højdepunkter: Bryggerset, der tilgås via køkkenets elementer og den mobile bordplade. Det er her, innovativ, rumlig indretning møder æstetisk raffinement.



**AV 7030**  
Black Star

**AV 6000**  
NCS S6020-R90B





Comfort with class









# Dark elegance – a design statement

Black fine oak is well received

An elegant kitchen that impresses with fronts in black fine oak with a light grain. The impressive natural stone splashback and worktop are interspersed with light-coloured and golden veins. High-quality materials and classic design create a stately ambience. Elements in natural umber bring warmth to the dining area. All the components radiate sophistication and display impressive beauty.

Ett elegant kök som imponerar med fronter i fin ek, svart med lätt ådring. Det imponerande stänkskyddet och bänkskivan i natursten är genombrutna av ljusa och gyllene ådror. Högkvalitativa material och klassisk design skapar en ståtlig atmosfär. Element i naturlig umbra ger värme till matplatsen. Alla komponenter utstrålar sofistikerad elegans och imponerande skönhet.

Una cucina elegante che colpisce per le ante in rovere fine nero con leggera venatura a poro aperto. Il suggestivo schienale ed il piano di lavoro in pietra naturale sono attarversati da venature chiare e dorate. Materiali di alta qualità e design classico creano un ambiente sontuoso. Elementi in terra d'ombra naturale donano calore alla zona pranzo. Tutti i componenti irradiano raffinatezza e sfoggiano una bellezza impressionante.

Et elegant køkken, der imponerer med fronter i fin eg-sort med en lyse åretegninger. Den imponerende stænkplade og bordpladen af natursten emmer af lyse og gyldne årer. Kvalitetsmaterialer og klassisk design skaber en herskabelig atmosfære. Elementer i umbra-natur spreder varme over spisepladsen. Alle komponenterne udstråler raffinement og imponerende skønhed.



## AV 2040

Black fine oak effect  
Fin ek svart effekt  
Effetto rovere fine nero  
Fin eg-sort effekt

## AV 6000

Natural umber  
Umbra naturlig  
Terra d'ombra naturale  
Umbra-natur



---

# Exclusive variety: Materials and colours skilfully combined

Preserving the good – shaping the new

Combining classic elegance with modern accents is extremely popular. The traditional and well-loved are skilfully combined with the contemporary. The choice of colours is often subtle and calming, while fine materials such as wood, glass and high-quality surfaces dominate. We will be happy to show you what modern kitchens look like that harmoniously combine past and present.

Att kombinera klassisk elegans med moderna accenter är extremt populärt. Det traditionella och omtyckta kombineras på ett skickligt sätt med det moderna. Färgvalen är ofta subtila och lugnande, medan fina material som trä, glas och högkvalitativa ytor dominerar. Vi visar dig gärna hur ett modernt kök som harmoniskt kombinerar dåtid och nutid ser ut.

La combinazione di eleganza classica con note moderne è estremamente popolare. Gli elementi tradizionali e popolari si alternano sapientemente con quelli contemporanei. Spesso la scelta dei colori cade su tonalità delicate e rilassanti, mentre materiali pregiati come il legno, il vetro e le superfici di qualità dominano l'ambiente. Saremo lieti di mostrare come si possono progettare cucine moderne fondendo armoniosamente passato e presente.

Det er ekstremt populært at kombinere klassisk elegance med moderne accenter. Det kendte og elskede kombineres omhyggeligt med det moderne. Farvevalget er typisk diskret og beroligende, mens ædle materialer, som træ og glas samt lækre overflader dominerer. Vi viser gerne, hvordan moderne køkkener, der harmonisk forener fortid og nutid, ser ud.





---

# NCS and RAL: Colour worlds in dialogue

Masterful colour variety in perfection

NCS and RAL are two internationally recognised colour systems in architecture. NCS colours offer a wide range of shades that precisely reproduce natural colours. RAL colours are standardised shades and defined colour codes that are used worldwide. When everyone speaks a common colour language, perfect colour matches can be achieved for different materials. We offer over 2,000 NCS colours and around 190 RAL shades.

NCS och RAL är två internationellt erkända färgsystem inom arkitektur. NCS-färger erbjuder ett brett utbud av nyanser som exakt återger naturliga färger. RAL-färger är standardiserade nyanser och definierade färgkoder, som används över hela världen. När alla talar ett gemensamt färgspråk kan man uppnå perfekta färgmatchningar för olika material. Vi erbjuder över 2.000 NCS-färger och cirka 190 RAL-nyanser.

NCS e RAL sono due sistemi di colori riconosciuti a livello internazionale in architettura. I colori NCS offrono un'ampia gamma di tonalità che riproducono con precisione i colori naturali. I colori RAL sono tonalità standardizzate e codici colore definiti che vengono utilizzati in tutto il mondo. Quando tutti parlano un linguaggio cromatico comune, è possibile ottenere abbinamenti perfetti tra i diversi materiali. Da noi troverai oltre 2.000 colori NCS e circa 190 tonalità RAL a tua disposizione.

NCS og RAL er to internationalt anerkendte farvesystemer, inden for arkitektur. NCS-farver tilbyder en bred vifte af nuancer, der gengiver naturlige farver præcist. RAL-farver er standardiserede toner og definerede farvekoder, som bruges i hele verden. Når alle taler et fælles farvesprog, opnår man det perfekte farvematch med forskellige materialer. Vi tilbyder over 2.000 NCS-farver og omkring 190 RAL-toner.

Balance and harmony with a personalised touch









# Everything in the green zone

New front design with facet

This customised kitchen design in an unmistakable shade of green impresses with fronts that feature a slightly bevelled edge all around. The soft green exudes calm elegance, while the Climber display cabinet emphasises this extraordinary kitchen. The worktop in carrara white adds visual interest. Innovative functionality and unique design make this kitchen an inspiring experience.

Denna skräddarsydda köksdesign i en omisskännlig grön nyans imponerar med fronter som har en lätt avrundad, fasad kant. Den mjukt gröna färgen utstrålar lugn elegans, medan vitrinskåpet Climber framhäver detta extraordinära kök. Bänkskivan i carrara vit mjukar upp looken. Innovativ funktionalitet och unik design gör det här köket till en inspirerande upplevelse.

Questa cucina personalizzata in un'inconfondibile tonalità di verde colpisce per le sue ante dal bordo delicatamente sfaccettato. Il verde tenue emana un'eleganza pacata, mentre la vetrina Climber enfatizza questa cucina straordinaria. Il top in carrara bianco cattura lo sguardo. Funzionalità innovativa e design unico rendono questa cucina un'esperienza stimolante.

Det skräddersyede køkkendesign, som fås i en helt unik, grøn nuance, imponerer med fronter, der har en let afrundet, affaset kant. Den bløde, grønne farve udstråler rolig elegance, mens vitrinen Climber præger det ekstraordinære køkken. Den carrara hvid bordplade fanger blikket. Innovativ funktionalitet og unikt design gør køkkenet til en inspirerende oplevelse.



AV 5075

NCS S 6010-B50G







# Colourfulness is not a must

Black and beige-brown create flair

Colours that don't push their way to the front show their full potential when used in combination. Modern kitchens in black and beige exude calm and serenity. They are the best partners for interior designs that focus on the relaxation factor. Both fronts in the narrow 10 mm frame harmonise perfectly with the beautiful grain of the surfaces in black oak and the handle in black chrome.

Färger, som inte tränger sig på, visar sin fulla potential när de kombineras med varandra. Moderna kök i svart och beige utstrålar lugn och ro. De är de bästa följeslagarna för inredningsdesign som fokuserar på avslappningsfaktorn. Båda fronterna i den smala 10 mm-ramen harmonierar perfekt med den vackra ådringen på ytorna i svart ek och handtaget i svart krom.

I colori meno appariscenti mostrano tutto il loro potenziale in combinazione con altre tonalità. Le cucine moderne in nero e beige emanano calma e serenità. Sono i migliori partner per i progetti di interni che puntano sul relax. Entrambi i modelli di anta con la stretta cornice da 10 mm armonizzano perfettamente con le splendide venature delle superfici in rovere nero e con le maniglie cromate nere.

Samspillet mellem farver, der ikke trænges sig på, viser deres fulde potentiale. Moderne køkkener i sort og beige udstråler fred og ro. De er perfekte partnere til indretning, der fokuserer på afslapning. Begge fronter, med den slanke ramme på 10 mm, matcher overfladernes smukke åretegninger, som ses i eg-sort, med håndtaget i sort krom.

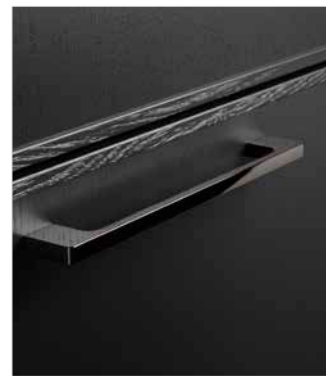

## AV 6065

Black oak

Ek svart

Rovere nero

Eg-sort

## AV 5065

NCS S 5005-Y50R









---

# Climber – Magical convenience for cabinets

Elegance in motion: By sensor control

Climber technology is revolutionising kitchen design with sensor-controlled glass elements that open and close. The design remains flawless without any handles or knobs. Tinted black glass, framed by narrow metal frames, integrates seamlessly into modern kitchen fronts. LED lights with colour temperature control set accents and present treasures in perfect light – innovation meets pure aesthetics.

Climber-tekniken revolutionerar köksdesignen med sensorstyrda glaselement som öppnas och stängs. Designen är fortfarande perfekt utan några handtag eller knoppar. Tonat svart glas, inramat av smala metallramar, integreras sömlöst i moderna köksfronter. LED-lampor med färgtemperaturkontroll sätter accenter och presenterar dyrgriparna i perfekt ljus - innovation möter ren estetik.

La tecnologia Climber sta rivoluzionando il design delle cucine con elementi in vetro controllati da sensori che aprono e chiudono la serrandina. Il design è impeccabile anche senza maniglie o pomelli. Il vetro nero, incorniciato da stretti telai metallici, si integra perfettamente nella cucina moderna. Le luci LED con regolazione della temperatura di colore creano suggestive atmosfere e sfoggiano i tesori in una luce perfetta: l'innovazione incontra l'estetica pura.

Climber-teknologien revolutionerer køkkenets design med sensorkontrollerede glaselementer, der selv åbner og lukker. Fuldendt design - helt uden håndtag. Tonet, sort glas, omgivet af slanke metalrammer, integreres let i moderne køkkenfronter. LED-lys med farvetemperaturstyring skaber stemning og præsenterer enhver skat i det perfekte skær - innovation møder ren æstetik.

# Interior for pull-out units and drawers

Perfect organisation with a system

With elegant drawer inserts and sophisticated pull-out dividers, pull-out units become a masterpiece of organisation. We offer various options for organising drawers and pull-out units individually and stylishly. Whether in synthetic or real wood – high-quality materials and well thoughtout design ensure that everything has its place – from the smallest spoon to the largest cooking utensil. The pull-out units also have integrated lighting for pull-out units.

Med eleganta lådinsatser och sofistikerade utdragsavdelare blir utdragbara skåp och lådor ett mästerverk av organisation. Vi erbjuder olika alternativ för att organisera utdragbara skåp och lådor på ett individuellt och snyggt sätt. Oavsett om de är i plast eller äkta trä - högkvalitativa material och genomtänkt design säkerställer att allt har sin plats - från den minsta skeden till det största köksredskapet. De utdragbara skåpen och lådorna har också integrerad utdragsbelysning.

Con eleganti portaposate nei cassetti e sofisticati divisori estraibili, i cassetti diventano un capolavoro dell'organizzazione. Proponiamo diverse opzioni per organizzare cassetti e cestoni in modo personale ed elegante. Che si tratti di plastica o di vero legno, i materiali di alta qualità e il design sofisticato garantiscono che ogni cosa abbia il suo posto, dal cucchiaino più piccolo all'utensile da cucina più grande. I cassetti sono inoltre dotati di sistema di illuminazione integrato.

De elegante skuffeindsatser og raffinerede inddelinger gør udtrækkene til organisatoriske mesterværker. Vi tilbyder forskellige muligheder for at organisere skuffer og udtræk individuelt og stilfuldt. Uanset om det er i plast eller ægte træ - sikrer kvalitetsmaterialer og gennemtænkt design, at alt har sin plads - fra den mindste ske til det største køkkengrej. Udtrækkene har tillige integreret udtræksbelysning.



Metro Box



Metro Glas



SLD Glas



---

# In the spotlight: Black chrome

Shimmering gloss sets design standards

The unique black chrome metal finish is conquering the world of design with its sophisticated, mysterious aura. Whether in interiors, for exclusive sports cars or in high-quality kitchens, the dark gloss lends any object a timeless elegance. Its unique mix of sophistication and modernity makes black chrome the preferred choice for those only willing to settle for the best.

Den unika Black Chrome-metallfinishen erövrar designvärlden med sin ädla, mystiska aura. Oavsett om det gäller interiörer, exklusiva sportbilar eller kök av hög kvalitet, ger den mörka lyster varje objekt en tidlös elegans. Den unika blandningen av sofistikerad och modern design gör Black Chrome till ett förstahandsval för dem som bara nöjer sig med det bästa.

L'esclusiva finitura metallica Black Chrome sa conquistare il mondo del design con la sua aura nobile e misteriosa. Che si tratti di interni, di auto sportive esclusive o di cucine di alta qualità, la cromatura nera conferisce a qualsiasi oggetto un'eleganza senza tempo. Il suo mix unico di raffinatezza e modernità rende il Black Chrome la scelta ideale per chi vuole solo il meglio.

Den unikke metalfinish, Black Chrome, erobrer designverdenen med sin elegante, mystiske aura. Uanset om det gælder indretning, eksklusive sportsvogne eller kvalitetskøkkener, tilføjer den mørke glans alt en tidløs elegance. Det unikke mix af raffinement og modernitet gør Sort krom til det perfekte valg for alle, der kun er tilfredse med det bedste.





---

# Design revolution for the interior

Black chrome shows elegance in detail

Masculine equipment details in Black Chrome combine function and style at the highest level. The dark, elegant sheen of the metal sets standards and becomes the favourite of modern interiors. Sophisticated details and high-quality workmanship transform cupboards and pull-outs into true design objects. Black Chrome also sets elegant accents as a handle variant in exclusive kitchens.

Maskulina utrustningsdetaljer i Black Chrome kombinerar funktion och stil på högsta nivå. Metallens mörka, eleganta lyster sätter standarden och blir en favorit i moderna interiörer. Sofistikerade detaljer och högkvalitativt utförande förvandlar skåp och utdrag till verkliga designobjekt. Black Chrome sätter också eleganta accenter som en variant av handtag i exklusiva kök.

Gli elementi nella finitura Black Chrome sanno coniugare funzionalità e stile ai massimi livelli. La scintillante eleganza della cromatura nera ridefinisce gli standard e diventa protagonista nel design degli interni moderni. Dettagli sofisticati e una lavorazione di alta qualità trasformano armadi e cassetti in veri e propri oggetti di design. Il Black Chrome crea accenti eleganti anche come maniglia nelle cucine esclusive.

Maskuline detaljer i Sort krom kombinerer funktion og stil til perfektion. Metallens mørke, elegante glans sætter standarden og bliver favoritten i moderne indretninger. Sofistikerede detaljer og forarbejdning i topkvalitet gør skabe og udtræk til ægte designobjekter. Sort krom sætter et ekstra elegant præg, som grebsvariant i eksklusive køkkener.

---

# Design classic wood

Lively, natural, timeless, sustainable

Wood, the material of nature, brings warmth and vitality to any room. Its unique grains tell stories and create a cosy atmosphere. Whether natural or refined – wood adapts to any style and lends timeless charm to kitchens, furniture and rooms. Sustainable and versatile, wood was, is and will remain an indispensable component of design.

Trä, naturens material, ger värme och vitalitet till alla rum. Dess unika ådring berättar historier och skapar en behaglig atmosfär. Oavsett om träet är naturligt eller förädlat - trä anpassar sig till alla stilar och ger tidlös charm till kök, möbler och rum. Hållbart och mångsidigt: Trä var, är och kommer att förbli en oumbärlig komponent i design.

Il legno, materiale naturale, dona calore e vitalità a qualsiasi ambiente. Le sue venature uniche raccontano storie e creano un'atmosfera accogliente. Al naturale o lavorato, il legno si adatta a qualsiasi stile e conferisce un fascino senza tempo a cucine, mobili e ambienti. Sostenibile e versatile, il legno era, è e rimarrà un elemento indispensabile del design.

Træ, naturens materiale, spreder varme og liv i ethvert rum. De unikke åretegninger fortæller historier og skaber en hyggelig atmosfære. Uanset om det er naturligt eller forædlet - træ tilpasser sig enhver stil og spreder tidløs charme over køkkener, møbler og værelser. Bæredygtigt og alsidigt, træ var - er - og vil fortsat være en uundværlig del af indretningen.





Exclusive variety: Skilfully combined design

Natural charisma with character





# Cheers to wood

Vertical grooves are visually and haptically appealing

For a grand entrance: this kitchen design impresses with a vertical grooved front made from the finest real wood veneer. The natural grain of the wood is visually emphasised by the fine grooves, giving the kitchen a unique texture and depth. The harmonious combination of natural wood and elements in graphite creates an inviting ambience.

För en storslagen entré: Den här köksdesignen imponerar med en vertikalt räfflad front av finaste äkta träfaner. Träets naturliga ådring framhävs visuellt av de fina räfflorna, som ger köket en unik struktur och ett djup. Den harmoniska kombinationen av naturligt trä och element i grafit skapar en inbjudande atmosfär.

Per un'entrata in grande stile: questa cucina colpisce per le ante cannellate impiallacciate in vero legno. Le venature naturali del legno sono esaltate dalle sottili scanalature, che conferiscono alla cucina una struttura e una profondità uniche. L'armoniosa combinazione di legno naturale ed elementi in grafite crea un ambiente invitante.

Skab en storstået entré: Dette køkkendesign imponerer med lodret rillede fronter, lavet af den fineste, ægte træfinér. Træets naturlige årer fremhæves visuelt af de fine riller, som giver køkkenet unik struktur og dybde. Den harmoniske kombination af naturligt træ og elementer i grafit skaber en indbydende atmosfære.

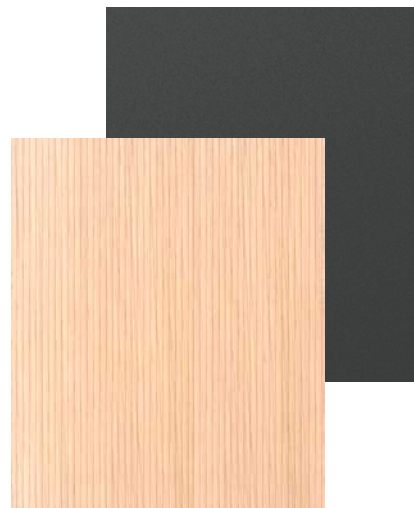

## AV 6023-GL

Elegant oak  
Elegant ek  
Rovere elegante  
Eg-elegant

## AV 6000-GL

Graphite  
Grafit  
Grafite  
Grafit













# Elegant in the right frame

Modern country house style

The soft colours and elegant front design with wide framing are impressive. Recessed grips and handles in a gold tone charmingly round off the look. The framing sets accents and, together with the high-quality materials and careful workmanship, creates a harmonious overall picture. Functionality and style are perfectly combined. A kitchen that impresses with its simple elegance.

De mjuka färgerna och den eleganta fronten med bred inramning är imponerande. Försänkta handtag och handtag i guldtön avrundar utseendet på ett charmigt sätt. Inramningen sätter accenter och skapar tillsammans med de högkvalitativa materialen och det omsorgsfulla utförandet en harmonisk helhetsbild. Funktionalitet och stil kombineras på ett perfekt sätt. Ett kök som imponerar med sin enkla elegans.

I colori tenui e l'elegante design delle ante con telaio largo sono di grande effetto. Maniglie e gole in tonalità oro completano il design in modo affascinante. Le ante a telaio caratterizzano la cucina e, insieme ai materiali di alta qualità e alla lavorazione accurata, creano un quadro d'insieme armonioso. Funzionalità e stile sono perfettamente complementari. Una cucina che colpisce per la sua eleganza minimalista.

Her imponerer de diskrete farver og det elegante frontdesign med brede rammer. Undersænkede greb i gyldne farver fuldender looket på charmerende vis. Matchet mellem indramningens unikke præg, kvalitetsmaterialerne og den omhyggelige forarbejdning skaber en harmonisk helhed. Den perfekte kombination af funktionalitet og stil. Et køkken, der imponerer med enkel elegance.



## AV 6055

Greige  
Greige  
Grigio-beige  
Grå

## AV 6000-GL

White  
Vit  
Bianco  
Hvid





# Equipment at a glance

Overview of the details



# Accentuation with light

Smart and energy-efficient

Modern types of lighting are design elements and offer functionality at the same time. Integrated LED light strips, spotlights and dimmable lamps provide targeted brightness on work surfaces or create an atmospheric ambience as ambient lighting. The innovative lighting solutions can be adjusted in terms of light colour and temperature. They always guarantee the best light output – whether in a recess, on a worktop or in shelves and display cabinets.

Moderna typer av belysning är designelement som erbjuder funktionalitet på samma gång. Integrerade LED-ljuslister, spotlights och dimbara lampor ger riktat ljus på arbetsytor och skapar en stämningsfull atmosfär som omgivningsbelysning. De innovativa belysningslösningarna kan justeras när det gäller ljusfärg och temperatur. De garanterar alltid bästa möjliga ljusutbyte - oavsett om det är i en vrå, på en bänkskiva eller i hyllor och vitrinskåp.

I moderni tipi di illuminazione sono elementi di design che offrono anche la massima funzionalità. Le strisce luminose a LED integrate, i faretti e le lampade dimmerabili forniscono una luminosità mirata sui piani di lavoro o creano un'atmosfera suggestiva. Con questi innovativi sistemi di illuminazione è possibile regolare il colore e la temperatura della luce. Garantiscono sempre la massima efficienza luminosa sia in una nicchia, sia su un piano di lavoro o su scaffali e vetrine.

Moderne belysning er designelementer, som tillige tilbyder funktionalitet. Integrerede LED-strips, spots og dæmpbare lamper spreder målrettet lys på arbejdsfladerne eller skaber en stemningsfuld atmosfære, som baggrundsbelysning. De innovative belysningsløsninger kan tilpasse lysets farve og temperatur. Det garanterer altid det bedste lysudbytte - uanset om det er i nicher, på bordplader, hylde eller i vitriner.



---

# SlimLine drawer in a new dimension

Optimised space with integrated light source

The SlimLine drawer, known as the SLD pull-out system, offers unimagined possibilities. The world's first 8 mm narrow steel frame from a single casting, integrated lighting for pull-out units and carcass depths of 610 and 710 mm. The less space the technology takes up, the more is left for the interior and the lighting sets the perfect scene for all the utensils.

SlimLine Drawer, även känd som SLD-utdragssystemet, erbjuder oanade möjligheter. Världens första 8 millimeter smala stålram från en enda gjutning, integrerad utdragsbelysning och stommar med djup på 610 och 710 mm. Ju mindre utrymme tekniken tar upp, desto mer blir över till inredningen, och belysningen skapar en perfekt inramning för alla redskap.

Lo SlimLine Drawer, noto come sistema SLD, offre possibilità inimmaginabili. La prima ferramenta per cassetti e cestoni con sponde spesse solo 8 mm, sistema di illuminazione dei cassetti integrata e profondità della scocca di 610 e 710 mm. Meno spazio occupa la tecnologia, più spazio rimane per gli interni e l'illuminazione crea una scena perfetta per tutti gli utensili.

SlimLine Drawer, kendt som udtrækssystemet SLD, giver uanede muligheder. Verdens første 8 millimeter smalle stålramme, skabt i én enkelt støbning, integreret udtræksbelysning og steldybder på 610 og 710 mm. Jo mindre teknologien fylder, des mere plads til indretningen, og belysningen sætter perfekt fokus på alt køkkenrej.







---

# Design carcass – Colour harmony all round

Uniform colour without compromise

The new designer carcass in natural fine oak stands out with its consistent colour scheme, which is the same colour inside and out. This continuous colour harmony lends cupboards and pull-outs a special elegance and ensures a uniform, high-quality appearance. No colour change disturbs the look – the carcass blends seamlessly into any modern interior. The designer carcass is available in the colours titanium, crystal white, light grey and now in natural fine oak.

Den nya designstommen i naturlig fin ek sticker ut med sin konsekventa färgskala, alltså samma färg på in- och utsidan. Denna genomgående färgharmonin ger skåp och utdragsenheter en speciell elegans och säkerställer ett enhetligt, högkvalitativt utseende. Inga färgförändringar stör utseendet - stommen smälter sömlöst in i alla moderna inredningar. Den designade stommen finns i färgerna titan, kristallvitt, ljusgrått och nu även i naturfärgad fin ek.

La nuova scocca di design in rovere fine naturale si distingue per la sua continuità cromatica, uguale sia all'interno che all'esterno. Questa armonia di colori conferisce agli armadi e ai cassetti una particolare eleganza e garantisce un aspetto uniforme e raffinato. Il cambio di colore non influenza l'estetica: il mobile si integra perfettamente in qualsiasi interno moderno. La scocca di design è disponibile nei colori titanio, bianco cristallo, grigio chiaro e ora anche in rovere fine naturale.

Det nye designerstel i fin eg-natur betager enhver med sit konsekvente farvevalg, der går igennem både ind- og udvendigt. Den gennemgående farveharmonien giver skabe og udtræk en særlig elegance og sikrer et ensartet kvalitetsindtryk. Ingen farveskift forstyrrer udseendet - stellet smelter let sammen med enhver moderne indretning. Designerstellet fås i farverne titan, krystalhvid, lysegrå og nu også i fin eg-natur.



**AV 1000 PG1** HPL | Laminat | Laminato | Laminat

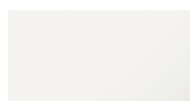

Polar white (ART)  
Polarvit (ART)  
Bianco polare (ART)  
Polarhvid (ART)

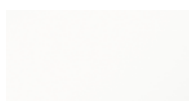

Crystal white (ART)  
Kristallvit (ART)  
Bianco cristallo (ART)  
Krystalhvid (ART)

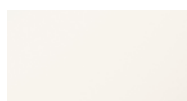

White (ART)  
Vit (ART)  
Bianco (ART)  
Hvid (ART)



Crema-magnolia (ART)  
Crema-magnolia (ART)  
Crema-magnolia (ART)  
Crème-magnolie (ART)



Taupe (ART)  
Satäng (ART)  
Satin (ART)  
Satin (ART)



Cashmere (ART)  
Kashmir (ART)  
Cachemire (ART)  
Cashmere (ART)



Light grey (ART)  
Ljusgrå (ART)  
Grigio chiaro (ART)  
Lysgrå (ART)



Sand grey (ART)  
Sandgrå (ART)  
Grigio sabbia (ART)  
Sandgrå (ART)



Greige (ART)  
Greige (ART)  
Grigio-beige (ART)  
Grå (ART)

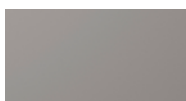

Pearl grey (ART)  
Pärigrå (ART)  
Grigio perla (ART)  
Perlegrå (ART)



Graphite (ART)  
Grafit (ART)  
Grafite (ART)  
Grafit (ART)



Black (ART)  
Svart (ART)  
Nero (ART)  
Sort (ART)

**AV 2010 PG1** Coated in melamine resin / Stone structure | Melaminhartsbeläggning / Stenstruktur | Rivestimento in resina melaminica / Struttura pietra / Belagt med melaminharpiks / Stenstruktur



Light cement effect (ART)  
Cement-ljus effekt (ART)  
Effetto cemento chiaro (ART)  
Cement-lys effekt (ART)



Grey cement effect (ART)  
Cement-grå effekt (ART)  
Effetto cemento grigio (ART)  
Cement-grå effekt (ART)



Dark cement effect (ART)  
Cement-mørk effekt (ART)  
Effetto Ciment foncé (ART)  
Cement-mørk effekt (ART)

# Equipment at a glance

## Fronts

**AV 2020 PG2** Coated in melamine resin / synchronous pore | Melaminhartsbeläggning / synkroniserade Porer | Rivestimento in resina melaminica / superficie sincroporo | Belagt med melaminharpiks / synkron pore



Natural luxor effect (ART) Brown luxor effect (ART)  
 Luxor-natur effekt (ART) Luxor-brun effekt (ART)  
 Effetto luxor naturale (ART) Effetto luxor marrone (ART)  
 Luxor-natur effekt (ART) Luxor-brun repro (ART)

**AV 2040 PG2** UV satin lacquer | Matt lack | Laccato opaco UV | Lakeret mat



Light fine oak (ART) Natural fine oak (ART) Black fine oak (ART)  
 Fin ek ljus (ART) Fin ek naturlig (ART) Fin ek svart (ART)  
 Rovere fine chiaro (ART) Rovere fine naturale (ART) Rovere fine nero (ART)  
 Fin eg-lys (ART) Fin eg-natur (ART) Fin eg-sort (ART)

**AV 2041 PG2** UV satin lacquer | UV matt lack | Laccato opaco UV | UV lakeret mat



Natural walnut effect (ART) Dark walnut effect (ART)  
 Valnöt naturlig effekt (ART) Valnöt mörk effekt (ART)  
 Effetto noce naturale (ART) Effetto noce scuro (ART)  
 Valdød Natur effekt (ART) Mørk Valdød effekt (ART)

**AV 2044 PG2** UV satin lacquer | UV matt lack | Laccato opaco UV | UV lakeret mat



Greige velvet oak effect (ART) Graphite velvet oak effect (ART) Black velvet oak effect (ART)  
 Sammetsek greige effekt (ART) Sammetsek grafit effekt (ART) Sammetsek svart effekt (ART)  
 Eff. overe velluto grigio-beige (ART) Effetto velluto grafite (ART) Effetto overe velluto nero (ART)  
 Eg grå effekt (ART) Fløjlseg-greige effekt (ART) Eg-sort effekt (ART)

**AV 2135 PG2** UV satin lacquer | UV matt lack | Laccato opaco UV | UV lakeret mat

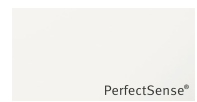

Natural walnut effect (ART) Dark walnut effect (ART) Greige velvet oak effect (ART) Graphite velvet oak effect (ART) Black velvet oak effect (ART) Polar white (ART)  
 Valnöt naturlig effekt (ART) Valnöt mörk effekt (ART) Sammetsek greige effekt (ART) Sammetsek grafit effekt (ART) Sammetsek svart effekt (ART) Polarvit (ART)  
 Effetto noce naturale (ART) Effetto noce scuro (ART) Eff. overe velluto grigio-beige (ART) Effetto velluto grafite (ART) Effetto overe velluto nero (ART) Bianco polare (ART)  
 Valdød Natur effekt (ART) Mørk Valdød effekt (ART) Eg grå effekt (ART) Fløjlseg-greige effekt (ART) Eg-sort effekt (ART) Polarhvid (ART)



Crystal white (ART) White (ART) Crema-magnolia (ART) Taupe (ART) Light grey (ART) Cashmere (ART)  
 Kristallvit (ART) Vit (ART) Crema-magnolia (ART) Satäng (ART) Ljusgrå (ART) Kashmir (ART)  
 Bianco cristallo (ART) Bianco (ART) Crema-magnolia (ART) Satin (ART) Grigio chiaro (ART) Cachemire (ART)  
 Krystallhvid (ART) Hvid (ART) Crema-magnolia (ART) Satin (ART) Lysgrå (ART) Cashmere (ART)

**AV 2130 PG2** UV high gloss lacquer | UV Höglanslack | Laccato lucido | brillante UV | UV højglanslakeret

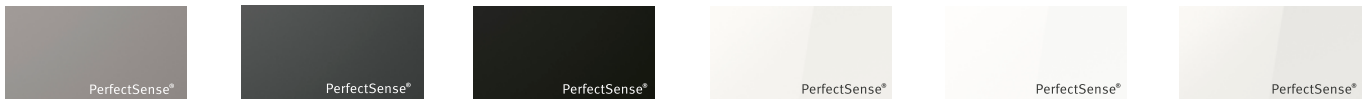

Pearl grey (ART) Graphite (ART) Black (ART) Polar white (ART) Crystal white (ART) White (ART)  
 Pärlgrå (ART) Grafit (ART) Svart (ART) Polarvit (ART) Kristallvit (ART) Vit (ART)  
 Grigio perla (ART) Grafite (ART) Nero (ART) Bianco polare (ART) Bianco cristallo (ART) Bianco (ART)  
 Perlegrå (ART) Grafit (ART) Sort (ART) Polarhvid (ART) Krystallhvid (ART) Hvid (ART)



Crema-magnolia (ART) Taupe (ART) Light grey (ART) Cashmere (ART) Pearl grey (ART) Graphite (ART)  
 Crema-magnolia (ART) Satäng (ART) Ljusgrå (ART) Kashmir (ART) Pärlgrå (ART) Grafit (ART)  
 Crema-magnolia (ART) Satin (ART) Grigio chiaro (ART) Cachemire (ART) Grigio perla (ART) Grafite (ART)  
 Crema-magnolia (ART) Satin (ART) Lysgrå (ART) Cashmere (ART) Perlegrå (ART) Grafit (ART)

**AV 4030 PG3** UV high gloss lacquer | UV Högglanslack | Laccato lucido brillante | UV højglanslakeret



Polar white (ART)  
Polarvit (ART)  
Bianco polare (ART)  
Polarhvid (ART)



Crystal white (ART)  
Kristallvit (ART)  
Bianco cristallo (ART)  
Krystalhvid (ART)



White (ART)  
Vit (ART)  
Bianco (ART)  
Hvid (ART)



Crema-magnolia (ART)  
Crema-magnolia (ART)  
Crema-magnolia (ART)  
Crema-magnolia (ART)



Taupe (ART)  
Satäng (ART)  
Satin (ART)  
Satin (ART)



Light grey (ART)  
Ljusgrå (ART)  
Grigio chiaro (ART)  
Lysgrå (ART)



Cashmere (ART)  
Kashmir (ART)  
Cachemire (ART)  
Cashmere (ART)



Pearl grey (ART)  
Pärigrå (ART)  
Grigio perla (ART)  
Perlegrå (ART)



Graphite (ART)  
Grafit (ART)  
Grafite (ART)  
Grafit (ART)



Black (ART)  
Svart (ART)  
Nero (ART)  
Sort (ART)

**AV 3050 PG3** HPL / Stone structure | Laminat / stenstruktur | Laminato / Struttura pietra | HPL / stenstruktur



Beige granite effect (ART)  
Granit-beige effekt (ART)  
Effetto granito beige (ART)  
Granit-beige effekt (ART)

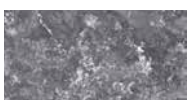

Dark grey granite effect (ART)  
Granit-mörkgrå effekt (ART)  
Effetto granito grigio scuro (ART)  
Granit-mørkegrå effekt (ART)



Satin lacquer | Matt lack |  
Laccato opaco | Lakeret mat

AV 6000 PG4

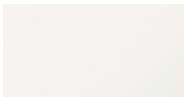

Polar white (ART)  
Polarvit (ART)  
Bianco polare (ART)  
Polarhvid (ART)

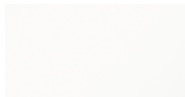

Crystal white (ART)  
Kristallvit (ART)  
Bianco cristallo (ART)  
Krystalhvid (ART)

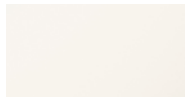

White (ART)  
Vit (ART)  
Bianco (ART)  
Hvid (ART)

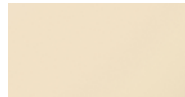

Crema-magnolia (ART)  
Crema-magnolia (ART)  
Crema-magnolia (ART)  
Crema-magnolia (ART)



Taupe (ART)  
Satäng (ART)  
Satin (ART)  
Satin (ART)



Light grey (ART)  
Ljusgrå (ART)  
Grigio chiaro (ART)  
Lysgrå (ART)



Cashmere (ART)  
Kashmir (ART)  
Cachemire (ART)  
Cashmere (ART)



Greige (ART)  
Greige (ART)  
Grigio-beige (ART)  
Grå (ART)



Sand grey (ART)  
Sandgrå (ART)  
Grigio sabbia (ART)  
Sandgrå (ART)



Pearl grey (ART)  
Pärlgrå (ART)  
Grigio perla (ART)  
Perlegrå (ART)



Natural umber (ART)  
Umbra naturlig (ART)  
Terra d'ombra naturale (ART)  
Umbra-natur (ART)



Eucalyptus (ART)  
Eukalyptus (ART)  
Eucalipto (ART)  
Eukalyptus (ART)



Velvet blue (ART)  
Sammetsblå (ART)  
Blu velluto (ART)  
Fløjlsblå (ART)



Graphite (ART)  
Grafit (ART)  
Grafito (ART)  
Grafit (ART)

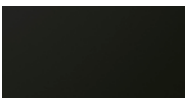

Black (ART)  
Svart (ART)  
Nero (ART)  
Sort (ART)



**AV 5045 PG5** Satin lacquer | Matt lack | Laccato opaco | Lakeret mat

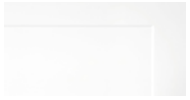

Crystal white (ART)  
Kristallvit (ART)  
Bianco cristallo (ART)  
Krystalhvid (ART)



White (ART)  
Vit (ART)  
Bianco (ART)  
Hvid (ART)



Crema-magnolia (ART)  
Crema-magnolia (ART)  
Crema-magnolia (ART)  
Crema-magnolia (ART)



Taupe (ART)  
Satäng (ART)  
Satin (ART)  
Satin (ART)



Light grey (ART)  
Ljusgrå (ART)  
Grigio chiaro (ART)  
Lysgrå (ART)



Cashmere (ART)  
Kashmir (ART)  
Cachemire (ART)  
Cashmere (ART)

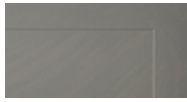

Greige (ART)  
Greige (ART)  
Grigio-beige (ART)  
Grå (ART)



Sand grey (ART)  
Sandgrå (ART)  
Grigio sabbia (ART)  
Sandgrå (ART)



Pearl grey (ART)  
Pärlgrå (ART)  
Grigio perla (ART)  
Perlegrå (ART)



Natural umber (ART)  
Umbraturlig (ART)  
Terra d'ombra naturale (ART)  
Umbratur (ART)



Eucalyptus (ART)  
Eukalyptus (ART)  
Eucalipto (ART)  
Eukalyptus (ART)



Velvet blue (ART)  
Sammetsblå (ART)  
Blu velluto (ART)  
Fløjlsblå (ART)



**AV 5035 PG5** Satin lacquer | Matt lack | Laccato opaco | Lakeret mat

Satin lacquer | Matt lack |  
Laccato opaco | Lakeret mat



Graphite (ART)  
Grafit (ART)  
Grafite (ART)  
Grafit (ART)



Black (ART)  
Svart (ART)  
Nero (ART)  
Sort (ART)



Crystal white  
Kristallvit  
Bianco cristallo  
Krystalhvid



White  
Vit  
Bianco  
Hvid



Crema-magnolia  
Crema-magnolia  
Crema-magnolia  
Crema-magnolia



Taupe  
Satäng  
Satin  
Satin



Light grey  
Ljusgrå  
Grigio chiaro  
Lysgrå



Cashmere  
Cachemir  
Cachemire  
Cashmere



Greige  
Greige  
Grigio-beige  
Grå



Sand grey  
Sandgrå  
Gris sable  
Sandgrå



Pearl grey  
Pärlgrå  
Grigio perla  
Perlegrå



Natural umber  
Umbraturlig  
Terra d'ombra naturale  
Umbratur



Eucalyptus  
Eucalipto  
Eukalyptus  
Eukalyptus



Velvet blue  
Sammetsblå  
Blu velluto  
Fløjlsblå



Graphite  
Grafit  
Grafite  
Grafit



Black  
Svart  
Nero  
Sort



AV 5085 PG5

Satin lacquer | Matt lack |  
Laccato opaco | Lakeret mat



Crystal white (ART)  
Kristallvit (ART)  
Bianco cristallo (ART)  
Krystalhvid (ART)



White (ART)  
Vit (ART)  
Bianco (ART)  
Hvid (ART)



Crema-magnolia (ART)  
Crema-magnolia (ART)  
Crema-magnolia (ART)  
Crema-magnolia (ART)



Taupe (ART)  
Satäng (ART)  
Satin (ART)  
Satin (ART)



Light grey (ART)  
Ljusgrå (ART)  
Grigio chiaro (ART)  
Lysgrå (ART)



Cashmere (ART)  
Kashmir (ART)  
Cashemire (ART)  
Cashmere (ART)



Greige (ART)  
Greige (ART)  
Grigio-beige (ART)  
Grå (ART)



Sand grey (ART)  
Sandgrå (ART)  
Gris sable (ART)  
Sandgrå (ART)



Pearl grey (ART)  
Pärlgrå (ART)  
Grigio perla (ART)  
Perlegrå (ART)



Natural umber (ART)  
Umbra naturlig (ART)  
Terra d'ombra naturale (ART)  
Umbra-natur (ART)



Eucalyptus (ART)  
Eukalyptus (ART)  
Eucalipto (ART)  
Eukalyptus (ART)



Velvet blue (ART)  
Sammetsblå (ART)  
Blu velluto (ART)  
Fløjlsblå (ART)

AV 5015 PG5 Polymer glass | Polymerglas | Vetro polimerico | Polymer glas



Graphite (ART)  
Grafit (ART)  
Grafite (ART)  
Grafit (ART)



Black (ART)  
Svart (ART)  
Nero (ART)  
Sort (ART)



Crystal white (ART)  
Kristallvit (ART)  
Bianco cristallo (ART)  
Krystalhvid (ART)

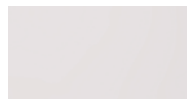

Misty grey (ART)  
Dimgrå (ART)  
Grigio nebbia (ART)  
Tågegrå (ART)



Sand beige (ART)  
Sandbeige (ART)  
Beige sabbia (ART)  
Sandgrå (ART)



Metallic sand grey (ART)  
Sandgrå metallic (ART)  
Grigio sabbia metallizzato (ART)  
Sandgrå metallic (ART)



Metallic stone grey (ART)  
Stengrå metallic (ART)  
Grigio pietra metallizzato (ART)  
Stengrå metallic (ART)



Metallic carbon (ART)  
Kol metallic (ART)  
Carbono metallizzato (ART)  
Carbon metallic (ART)



Metallic olive green (ART)  
Olivgrön metallic (ART)  
Verde oliva metallizzato (ART)  
Olivengrøn metallic (ART)



**AV 6095 PG6** Glass 3 mm satinad | Glas 3 mm satinerad | Vetro spessore 3 mm satinato | Glas 3 mm satineret



Crystal white (ART)	Graphite (ART)	Black (ART)
Kristallvit (ART)	Grafit (ART)	Svart (ART)
Bianco cristallo (ART)	Grafite (ART)	Nero (ART)
Krystalhvid (ART)	Grafit (ART)	Sort (ART)

**AV 6090 PG6** Glas 3 mm glänzend | Glas 3 mm glänsande | vetro spessore 3 mm lucido / lucida | Glas 3 mm blankt



Crystal white (ART)	Graphite (ART)
Kristallvit (ART)	Grafit (ART)
Bianco cristallo (ART)	Grafite (ART)
Krystalhvid (ART)	Grafit (ART)



**AV 5065 PG6** Satin lacquer | Matt lack | Laccato opaco | Lakeret mat



Crystal white (ART)	White (ART)	Crema-magnolia (ART)	Taupe (ART)	Light grey (ART)	Cashmere (ART)
Kristallvit (ART)	Vit (ART)	Crema-magnolia (ART)	Satäng (ART)	Ljusgrå (ART)	Cachemir (ART)
Bianco cristallo (ART)	Bianco (ART)	Crema-magnolia (ART)	Satin (ART)	Grigio chiaro (ART)	Cachemire (ART)
Krystalhvid (ART)	Hvid (ART)	Crema-magnolia (ART)	Satin (ART)	Lysgrå (ART)	Cashmere (ART)



Greige (ART)	Sand grey (ART)	Pearl grey (ART)	Natural umber (ART)	Eucalyptus (ART)	Velvet blue (ART)
Greige (ART)	Sandgrå (ART)	Pärlgrå (ART)	Umbraturlig (ART)	Eukalyptus (ART)	Sammetsblå (ART)
Grigio-beige (ART)	Grigio sabbia (ART)	Grigio perla (ART)	Terra d'ombra naturale (ART)	Eucalipto (ART)	Blu velluto (ART)
Grå (ART)	Sandgrå (ART)	Perlegrå (ART)	Umbratur (ART)	Eukalyptus (ART)	Fløjlsblå (ART)



Graphite (ART)	Black (ART)
Grafit (ART)	Svart (ART)
Grafite (ART)	Nero (ART)
Grafit (ART)	Sort (ART)

# Equipment at a glance

## Fronts



### AV 5075 PG6

Satin lacquer | Matt lack |  
Laccato opaco | Lakeret mat

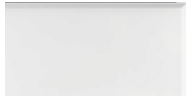

Crystal white (ART)  
Kristallvit (ART)  
Bianco cristallo (ART)  
Krystalhvid (ART)



White (ART)  
Vit (ART)  
Bianco (ART)  
Hvid (ART)



Crema-magnolia (ART)  
Crema-magnolia (ART)  
Crema-magnolia (ART)  
Crema-magnolia (ART)



Taupe (ART)  
Satäng (ART)  
Satin (ART)  
Satin (ART)



Light grey (ART)  
Ljusgrå (ART)  
Grigio chiaro (ART)  
Lysgrå (ART)



Cashmere (ART)  
Kashmir (ART)  
Cachemire (ART)  
Cashmere (ART)



Greige (ART)  
Greige (ART)  
Grigio-beige (ART)  
Grå (ART)



Sand grey (ART)  
Sandgrå (ART)  
Grigio sabbia (ART)  
Sandgrå (ART)



Pearl grey (ART)  
Pärlgrå (ART)  
Grigio perla (ART)  
Perlegrå (ART)



Natural umber (ART)  
Umbraturlig (ART)  
Terra d'ombra naturale (ART)  
Umbratur (ART)



Eucalyptus (ART)  
Eukalyptus (ART)  
Eucalipto (ART)  
Eukalyptus (ART)



Velvet blue (ART)  
Sammetsblå (ART)  
Blu velluto (ART)  
Fløjlsblå (ART)



### AV 6035 PG6

Ash lacquer real wood frame veneered center panel | Ek lakerad, massiv stomme, fyllning med faner |  
Frassino laccato telaio massello fodrina impiallacciata | Lakeret ramme i ask



Graphite (ART)  
Grafit (ART)  
Grafite (ART)  
Grafit (ART)

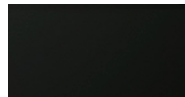

Black (ART)  
Svart (ART)  
Nero (ART)  
Sort (ART)

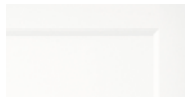

Crystal white  
Kristallvit  
Bianco cristallo  
Krystalhvid

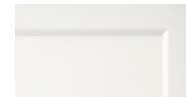

White  
Vit  
Bianco  
Hvid



Crema-magnolia  
Crema-magnolia  
Crema-magnolia  
Crema-magnolia



Taupe  
Satäng  
Satin  
Satin



Light grey  
Ljusgrå  
Grigio chiaro  
Lysgrå



Cashmere  
Kashmir  
Cachemire  
Cashmere



Greige  
Greige  
Grigio-beige  
Grå



Sand grey  
Sandgrå  
Grigio sabbia  
Sandgrå



Pearl grey  
Pärlgrå  
Grigio perla  
Perlegrå



Natural umber  
Umbraturlig  
Terra d'ombra naturale  
Umbratur



Eucalyptus  
Eukalyptus  
Eucalipto  
Eukalyptus



Pastel green  
Pastellgrön  
Verde pastello  
Pastelgrön



Agate blue  
Agatblå  
Agata blu  
Agatblå



Velvet blue  
Sammetsblå  
Blu velluto  
Fløjlsblå



Graphite  
Grafit  
Grafite  
Grafit

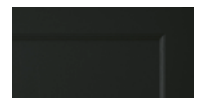

Black  
Svart  
Nero  
Sort



Ash lacquer real wood frame veneered center panel | Ek lackerad, massiv stomme, fyllning med faner |  
Frassino laccato telaio massello fodrina impiallacciata | Lakeret rammelåge i ask

### AV 6055 PG6



Crystal white (ART)  
Kristallvit (ART)  
Bianco cristallo (ART)  
Krystalhvíd (ART)



White (ART)  
Vit (ART)  
Bianco (ART)  
Hvid (ART)



Crema-magnolia (ART)  
Crema-magnolia (ART)  
Crema-magnolia (ART)  
Crema-magnolia (ART)



Taupe (ART)  
Satäng (ART)  
Satin (ART)  
Satin (ART)



Light grey (ART)  
Ljusgrå (ART)  
Grigio chiaro (ART)  
Lysgrå (ART)



Cashmere (ART)  
Kashmir (ART)  
Cachemire (ART)  
Caashmere (ART)



Greige (ART)  
Greige (ART)  
Grigio-beige (ART)  
Grå (ART)



Sand grey (ART)  
Sandgrå (ART)  
Grigio sabbia (ART)  
Sandgrå (ART)



Pearl grey (ART)  
Pärigrå (ART)  
Grigio perla (ART)  
Perlegrå (ART)



Natural umber (ART)  
Umbra naturlig (ART)  
Terra d'ombra naturale (ART)  
Umbra-natur (ART)



Eucalyptus (ART)  
Eukalyptus (ART)  
Eucalipto (ART)  
Eukalyptus (ART)



Pastel green (ART)  
Pastellgrön (ART)  
Verde pastello (ART)  
Pastelgrön (ART)



Agate blue (ART)  
Agatblå (ART)  
Agata blu (ART)  
Agatblå (ART)

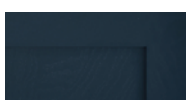

Velvet blue (ART)  
Sammetsblå (ART)  
Blu velluto (ART)  
Fløjlsblå (ART)



Graphite (ART)  
Grafit (ART)  
Grafite (ART)  
Grafit (ART)



Black (ART)  
Svart (ART)  
Nero (ART)  
Sort (ART)



**AV 6086 PG7** Real wood veneer brushed | Åkta trä borstad faner |  
Vero legno impiallacciato spazzolato | Fineret ægte træ



Elegant oak (ART)  
Elegant ek (ART)  
Rovere elegante (ART)  
Eg-elegant (ART)



Black oak (ART)  
Ek svart (ART)  
Rovere nero (ART)  
Eg-sort (ART)



Elegant walnut (ART)  
Valnöt elegant (ART)  
Noce elegante (ART)  
Valnød-elegant(ART)

**AV 6088 PG7** Real wood veneer brushed | Åkta trä borstad faner |  
Vero legno impiallacciato spazzolato | Fineret ægte træ



Elegant oak (ART)  
Elegant ek (ART)  
Rovere elegante (ART)  
Eg-elegant (ART)



Black oak (ART)  
Ek svart (ART)  
Rovere nero (ART)  
Eg-sort (ART)



Elegant walnut (ART)  
Valnöt elegant (ART)  
Noce elegante (ART)  
Valnød-elegant(ART)

**AV 7010 PG8** Mineral putty concrete | Mineralisk avjämningbetong |  
Calcestruzzo minerale | Mineralsk udjævningsbeton



Light concrete (ART)    Grey concrete (ART)    Dark concrete (ART)  
 Betong-ljus (ART)    Betong-grå (ART)    Betong-mörk (ART)  
 Calcestruzzo chiaro (ART)    Calcestruzzo grigio (ART)    Calcestruzzo scuro (ART)  
 Beton-lys (ART)    Beton-grå (ART)    Beton-mørk (ART)

**AV 6065 PG8** Real wood veneer brushed | Borstad fanér i äkta trä |  
Vero legno impiallacciato spazzolato | Fineret ægte træ



Elegant oak (ART)    Black oak (ART)    Elegant walnut (ART)  
 Elegant ek (ART)    Ek svart (ART)    Nötträd elegant (ART)  
 Rovere elegante (ART)    Rovere nero (ART)    Noce elegante (ART)  
 Eg-elegant (ART)    Eg-sort (ART)    Valnød-elegant (ART)

**AV 6080 PG8** Real wood veneer brushed | Äkta trä borstad fanér | Vero legno  
impiallacciato spazzolato | Fineret ægte træ



Natural wild oak (ART)    Nougat wild oak (ART)    Walnut (ART)  
 Vild ek naturlig (ART)    Vild ek nougat (ART)    Valnöt (ART)  
 Rovere selvatico naturale (ART)    Rovere selvatico nougat (ART)    Noce (ART)  
 Vild eg-natur (ART)    Vild eg-nougat (ART)    Valnød (ART)

**AV 6082 PG8** Real wood veneer brushed | Äkta trä borstad fanér |  
Vero legno impiallacciato spazzolato | Fineret ægte træ



Natural wild oak (ART)    Nougat wild oak (ART)    Walnut (ART)  
 Vild ek naturlig (ART)    Vild ek nougat (ART)    Valnöt (ART)  
 Rovere selvatico naturale (ART)    Rovere selvatico nougat (ART)    Noce (ART)  
 Vild eg-natur (ART)    Vild eg-nougat (ART)    Valnød (ART)

**AV 7070 PG8** Metallic lacquer smoothed | Metallcårg elegant |  
Laccatura metallizzata levigato | Malet metallak



Industrial steel (ART)    Bronze (ART)  
 Industristål (ART)    Bronze (ART)  
 Acciaio industrial (ART)    Bronzo (ART)  
 Industristål (ART)    Bronze (ART)



**AV 7030 PG9** Stone veneered | Piedra chapado |  
Struttura piedra | Sten finér

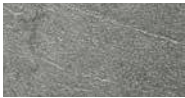

Silver-star (ART)



Black-star (ART)

**AV 7080 PG9** Linoleum | Linoleum | Linoleum | Linoleum

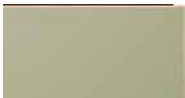

Sage green (ART)  
Salviagrön (ART)  
Verde salvia (ART)  
Salviegrön (ART)

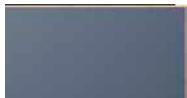

Smoky blue (ART)  
Rökblå (ART)  
Blu fumo (ART)  
Røgblå (ART)

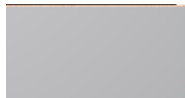

Silk grey (ART)  
Silkesgrå (ART)  
Grigio seta (ART)  
Silkegrå (ART)



Black  
Negro  
Nero  
Sort

**AV 6084 PG9** Real wood veneer embossed | Äkta trä präglad faner |  
Vero legno impiallacciato goffrato | Fineret ægte træ



Reclaimed wood (ART)  
Gammalt trä (ART)  
Legno antico (ART)  
Gammelt træ (ART)



Smoked oak (ART)  
Rökt ek (ART)  
Rovere bruciato (ART)  
Røget Eg (ART)



Volcano oak (ART)  
Vulkanek (ART)  
Rovere vulcano (ART)  
Vulkaneg (ART)

**AV 6023 PG10** Real wood veneered / Grooved front | Äkta trä räfflad front / faner |  
Vero legno impiallacciato / Scanalatura fitta | Ægte træfiner / Riliet front



Elegant oak (ART)  
Elegant ek (ART)  
Rovere elegante (ART)  
Eg-elegant (ART)



Black oak (ART)  
Ek svart (ART)  
Rovere nero (ART)  
Eg-sort (ART)



Elegant walnut (ART)  
Valnöt elegant (ART)  
Noce elegante (ART)  
Valnød-elegant (ART)

**AV 6085-GL PG10** Real wood veneered / Rattan | Fanér av äkta trä / rotting |  
Vero legno impiallacciato / Paglia di Vienna | Ægte træfiner / Rattan



Elegant oak (ART)  
Elegant ek (ART)  
Rovere elegante (ART)  
Eg-elegant (ART)



Black oak (ART)  
Ek svart (ART)  
Rovere nero (ART)  
Eg-sort (ART)



Elegant walnut (ART)  
Valnöt elegant (ART)  
Noce elegante (ART)  
Valnød-elegant (ART)







## Equipment at a glance

### Worktops



Arizona pine effect  
Pinje Arizona effekt  
Effetto pino arizona  
Arizona fyrtræ effekt



Light fine oak effect  
Fin ek ljus effekt  
Effetto rovere fine chiaro  
Fin eg-lys effekt



Natural fine oak effect  
Fin ek naturlig effekt  
Effetto rovere fine naturale  
Fin eg-natur effekt



Black fine oak effect  
Fin ek svart effekt  
Effetto rovere fine nero  
Fin eg-sort effekt



Torino oak effect  
Ek Torino effekt  
Effetto rovere torino  
Eg-torino effekt



Venezia oak effect  
Ek Venezia effekt  
Effetto rovere venezia  
Eg-venezia repro



Light summer oak effect  
Sommarek ljus effekt  
Effetto farnia chiara  
Lys Sommer Eg effekt



Summer oak effect  
Sommarek effekt  
Effetto farnia  
Sommer Eg effekt



Summer oak silver-grey effect  
Sommarek silvergrå effekt  
Effetto farnia grigio argento  
Sommer Eg sølvgrå effekt



Natural walnut effect  
Valnöt naturlig effekt  
Effetto noce naturale  
Valnød-natur effekt



Natural vintage oak effect  
Antik ek naturlig effekt  
Effetto rovere antico naturale  
Gammel eg-natur effekt



Alpine oak effect  
Alpin ek effekt  
Effetto Rovere alpino  
Alpine Eg effekt



Ontario oak effect  
Ek Ontario effekt  
Effetto rovere ontario  
Ontario Eg effekt



Walnut effect  
Valnöt effekt  
Effetto noce  
Valnød effekt



Dark walnut effect  
Valnöt mörk effekt  
Effetto noce scuro  
Valnød-mørk effekt



Mocha elm effect  
Alm mocka effekt  
Effetto olmo moka  
Elm-mokka effekt



Natural oak grain-cut timber effect  
Ek ändträ grå effekt  
Effetto rovere duramen naturale  
Natur Eg Endetræ effekt



Natural luxor effect  
Luxor-natur effekt  
Effetto luxor naturale  
Luxor-natur effekt



Brown luxor effect  
Luxor-brun effekt  
Effetto luxor marrone  
Luxor-brun effekt

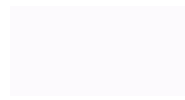

Polar white  
Polarvit  
Bianco polare  
Polarhvid



Crystal white  
Kristallvit  
Bianco cristallo  
Krystalhvid



White  
Vit  
Bianco  
Hvid

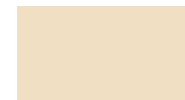

Crema-magnolia  
Crema-magnolia  
Crema-magnolia  
Crema-magnolia

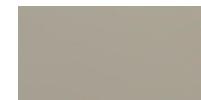

Taupe  
Satäng  
Satin  
Satin



Cashmere  
Kashmir  
Cachemire  
Cashmere



Light grey  
Ljusgrå  
Grigio chiaro  
Lysegrå



Pearl grey  
Pärlgrå  
Grigio perla  
Perlegrå



Graphite  
Grafit  
Grafite  
Grafit



Black  
Svart  
Nero  
Sort



Sand grey  
Sandgrå  
Grigio sabbia  
Sandgrå



Greige  
Greige  
Grigio-beige  
Grå



Luna dark effect  
Luna-mørk effekt  
Effetto Luna scura  
Luna-mørk effekt



Travertine effect  
Travertine effekt  
Effetto travertino  
Travertine effekt



Turquoise granite effect  
Granit-turkis effekt  
Effetto granito turchese  
Granit-turkos effekt



Beige granite effect  
Granit-beige effekt  
Effetto granito beige  
Granit-beige effekt



Dark grey granite effect  
Granit-mørkgrå effekt  
Effetto granito grigio scuro  
Granit-mørkegrå effekt

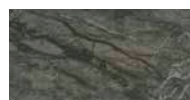

Niagara effect  
Niagara effekt  
Effetto Niagara  
Niagara effekt



Limestone effect  
Kalksten reproduktion  
Effetto calcarea  
Kalksten repro



Quartz grey effect  
Kvartsgrå effekt  
Effetto quarzo grigio  
Kvartsgrå effekt



Light moon stone effect  
Månsten ljus effekt  
Effetto pietra di luna chiara  
Lys Månsten effekt



Grey limestone effect  
Kalksten grå effekt  
Effetto pietra calcarea grigia  
Grå Kalksten effekt

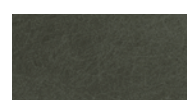

Brushed steel effect  
Borstat stål effekt  
Effetto acciaio spazzolato  
Stål børstet effekt



Black steel effect  
Svart stål effekt  
Effetto acciaio nero  
Sort Stål effekt



Basalt brown effect  
Basalt brun effekt  
Effetto marrone basalto  
Basalt brun effekt



Marble anthracite effect  
Marmor antracit effekt  
Effetto marmo antracite  
Antracit marmor effekt



Green marble effect  
Marmor grön effekt  
Effetto marmo verde  
Marmor-grøn repro



Putty concrete opal grey effect  
Betong opalgrå effekt  
Eff. calcestr. spat. grigio opale  
Beton opalgrå effekt



Putty concrete pearl grey effect  
Betong pärlgrå effekt  
Effetto calcestruzzo spatolato grigio perla  
Beton perlegrå effekt



Putty concrete graphite effect  
Betong grafit effekt  
Effetto calcestruzzo spatolato grafite  
Beton grafit effekt



Putty concrete black effect  
Betong svart effekt  
Effetto calcestruzzo spatolato nero  
Beton sort effekt



Light cement effect  
Betong-lyus effekt  
Effetto cemento chiaro  
Cement-lyus effekt



Grey cement effect  
Betong-grå effekt  
Effetto cemento grigio  
Beton-grå effekt



Dark cement effect  
Betong-mørk effekt  
Effetto cemento scuro  
Cement-mørk effekt



PerfectSense®  
Grey marble effect  
Marmor grå effekt  
Effetto marmo grigio  
Marmor Grå effekt

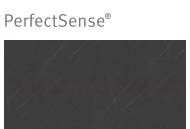

Marble dark effect  
Marmor mørk effekt  
Effetto marmo scuro  
Mørk Marmor effekt



PerfectSense®  
Carrara white effect  
Carrara vit effekt  
Effetto carrara bianco  
Carrara hvid effekt



101



102



105



113



114



112



117



343



378



385



386



308



379



440



446



524



302



312



318



319



332



344



372



373



374



377



380



423



427



441



452



502



503



504



505



# Equipment at a glance

## Handles

506



507



508



512



513



514



515



520



521



522



526



534



543



552



553



554



556



557



558



561



564



430



435



437



458



466



467



469



479



484



485



495



436



528



570



613



M 731



M 732



M 376



M 421



M 562



M 375



B 615



B 550



B 624



B 535



M 530



M 527



M 542



M 721



M 755



M 767



M 720



M 722



M 745



M 777



M 790



M 791



M 792



M 780



M 783



PTO1







**We reserve the right to alter sizes and specification of goods without notice and are not liable for printing errors. This catalogue supercedes previous catalogues.**

Med förbehåll för ändringar i program, material, design och dimensioner. Alla inredningsexempel är icke bindande. Vi förbehåller oss rätten att korrigera tryckfel. Med publiceringen av denna katalog förlorar alla tidigare kataloger sin giltighet.

Con riserva di modifiche riguardanti programma, materiali, esecuzione, dimensioni. Gli esempi di arredamento mostrati non sono impegnativi. Con riserva di correzione di eventuali errori di stampa. La pubblicazione del presente catalogo annulla tutti i cataloghi precedenti.

Forbehold for ændringer i programmet, materialet, udførelsen og målene. Alle indretningseksempler er uden forbindende. Forbehold for trykfejl. Med udgivelsen af dette katalog er alle foregående udgaver ugyldige.

Kitchen planning with a system  
Impressively stylish

**systemat**

Printed 09-2024



